

Index

SERIES NUMBER **PAGE**

STANDARD HOSE FITTINGS	
102	Male Pipe..... 2
102-SS	Male Pipe-Stainless..... 2
102-BSPT	Male Pipe-British Thread..... 2
103	Male Pipe Swivel..... 3
104	Female Pipe..... 3
104-SS	Female Pipe-Stainless Steel..... 3
105	Female Pipe Swivel..... 4
124	Female Swivel-Ball Seat..... 4
126	Female Swivel-Gasket Seat..... 4
129	90° Elbow, Male Pipe..... 5
129-SS	90° Elbow, Male Pipe-Stainless Steel..... 5
134	90° Elbow, Female Pipe..... 5
139	45° Elbow, Male Pipe..... 6
142	Male 45° SAE..... 6
143	Female Swivel 45° SAE/37° JIC Dual Angle Seat..... 6
144	Female Swivel 45° SAE..... 7
145	Female Swivel 37° JIC..... 7
177	90° Elbow Splicer..... 7
2012 177-SS	90° Elbow Splicer-Stainless Steel..... 8
178	Hose Splicer..... 8
178-SS	Hose Splicer-Stainless Steel..... 8
179	Tee Splicer..... 9
2012 179-SS	Tee Splicer-Stainless Steel..... 9

WELDING CONNECTORS	
152	Right Hand Thread (Oxygen Line)..... 10
154	Left Hand Thread (Acetylene Line)..... 10
156	Adapter-Right Hand Thread x NPTF Thread..... 11
158	Adapter-Left Hand Thread x NPTF Thread..... 11

BRASS FERRULES & CRIMPING TOOL	
200	Stamped Brass Ferrules..... 12
200-FC	Ferrule Crimper..... 12

RE-USABLE FITTINGS	
180	Ferrule Only..... 14
180-SS	Ferrule Only-Stainless Steel..... 14
182	Male Stem Only..... 14
182-SS	Male Stem Only-Stainless Steel..... 14
183	Reusable Set- Ferrule and Male Stem..... 15
183-SS	Reusable Set- Stainless Steel..... 15
184	Female Swivel Stem Only..... 16
185	Reusable Set- Ferrule and Female Swivel Stem..... 16
187	Hose Splicer (Ferrules and Splicer)..... 17

SERIES NUMBER **PAGE**

BEADED HOSE FITTINGS	
268B	Male Pipe..... 17

LOK-ON (Push-on Style) HOSE FITTINGS	
270-AT	Assembly Tool..... 18
271	Male Pipe Swivel..... 18
272	Male Pipe..... 19
272W	Yellow Lok-on Cap..... 19
NEW 272-SS	Male Pipe-Stainless Steel..... 19
273	90° Elbow, Male Pipe..... 20
274	Female Pipe..... 20
2012 278	Female Swivel-Ball Seat..... 21
280	Female Swivel-Gasket Seat..... 21
282	Male 45° SAE..... 21
284	Female Swivel 45° SAE..... 22
286	Male 37° JIC..... 22
287	Female Swivel 45° SAE/37° JIC Dual Angle Seat..... 22
287-SS	Female Swivel 45° SAE/37° JIC Dual Angle Seat-Stainless Steel..... 22
288	Female Swivel 37° JIC..... 23
288-SS	Female Swivel 37° JIC-Stainless Steel..... 23
289	Female Swivel 90° Elbow..... 23
290	Male Swivel SAE Inverted Flare..... 23
292	Female SAE Inverted Flare..... 24
294	Rigid Tube Shank..... 24
296	Hose Splicer..... 24
296-SS	Hose Splicer-Stainless Steel..... 24

BRASS PIPE FITTINGS	
163	Hex Head Plug..... 25
165	Close Pipe Nipple..... 25
166	Long Pipe Nipple..... 25-26
169	90° Male Pipe Elbows..... 26
172	Male Union-NPSM x NPTF..... 26
174	Adapter-Male NPSM x Female NPTF..... 26
176	Male Union-NPSM..... 27
207-BH	Bulkhead Anchor Coupling..... 27
211	Square Head Plug..... 27
213	Pipe Cap..... 28
219	Hex Socket Plug..... 28
228	Female Cross..... 28
302	90° Female Elbow..... 29
304	90° Street Elbow..... 29
306	45° Street Elbow..... 29
322	Female Tee..... 30
324	Male Branch Tee..... 30
326	Street Tee..... 30
370	Male Hex Nipple..... 31
371	Female Hex Coupling..... 31
373	Reducer Bushing..... 31
375	Adapter-Female x Male..... 32
377	Reducing Coupler-Double Female..... 32
379	Male Reducing Hex Nipple..... 32

Index

**SERIES
NUMBER**

PAGE

**SERIES
NUMBER**

PAGE

GARDEN HOSE FITTINGS

NEW 500	Garden Hose Accessory Products.....	33
501	Female Hose x Female Pipe, non-swivel	34
501-SS	Female Hose x Female Pipe, non-swivel Stainless Steel.....	34
502	Female Hose x Female Pipe, swivel.....	34
502-SS	Female Hose x Female Pipe, swivel Stainless Steel.....	34
503	Female Hose x Male Pipe, non-swivel.....	34
503-SS	Female Hose x Male Pipe, non-swivel Stainless Steel.....	34
504	Female Hose x Male Pipe, swivel.....	34
504-SS	Female Hose x Male Pipe, swivel Stainless Steel.....	34
506	Female Hose x Female Hose, swivel	35
507	Male Hose x Female Pipe.....	35
507-SS	Male Hose x Female Pipe - Stainless Steel.....	35
508	Male Hose x Male Pipe.....	35
508-SS	Male Hose x Male Pipe - Stainless Steel.....	35
509	Male Hose x Male Hose.....	35
509-SS	Male Hose x Male Hose - Stainless Steel.....	35
513	Hose Cap.....	36
514	Male Hose x Male Pipe x Female Pipe.....	36
578	Garden Hose Mender	36
585	Short Shank Male	36
586	Short Shank Female Swivel, round nut	37
587	Short Shank Set (male and female swivel), round nut.....	37
588	Short Shank Female Swivel, hex nut.....	37
589	Short Shank Set (male and female swivel), hex nut	37
590	Garden Hose Male.....	38
590-SS	Garden Hose Male - Stainless Steel.....	38
591	Garden Hose Female Swivel	38
591-SS	Garden Hose Female - Stainless Steel	38
592	Garden Hose Set (male and female swivel)	38
592-SS	Garden Hose Set (male and female swivel) - Stainless Steel	38
593	Long Shank Male.....	39
594	Long Shank Female Swivel	39
595	Long Shank Set (male and female swivel)	39

COMPRESSION FITTINGS

60C	Sleeve.....	41
60PT	Delrin® Sleeve.....	41
61C	Nut	41
61CL	Long Nut.....	41
62C	Union	42
62CBH	Bulkhead Union	42
63PT	Brass Insert.....	42
66C	Female Connector	43
68C	Male Connector	43
164C/		
264C	Union Tee.....	44
165C	Union Elbow.....	44
169C	Male Elbow	45
170C	Female Elbow	45
171C	Male Run Tee.....	45
172C	Male Branch Tee.....	46
176C	Adapter Tee	46
177C	Female Branch Tee.....	46
179C	45° Elbow	46
639C	Seal Plug	47
682C	Straight Thru Tank Fitting.....	47

D.O.T. AIR BRAKE FITTINGS

60NAB	Sleeve.....	48
61NAB	Nut	49
62NAB	Union	49
62NABH	Bulkhead Union	49
62NBH	Bulkhead Union	49
62NFBH	Bulkhead Union	50
63NAB	Stainless Insert	50
64NAB	Union Tee.....	50
65NAB	Union Elbow.....	51
66NBH	Bulkhead Union	51
66NAB	Female Connector	51
68NAB	Male Connector	52
69NAB	Male Elbow	52
70NAB	Female Elbow	53
71NAB	Male Run Tee.....	53
72NAB	Male Branch Tee.....	54
79NAB	45° Elbow	54
NAB	Nylon Tubing.....	48
TC97	Tubing Cutter	48

GWH	Grease Whip Hose Assemblies, Coupler and Fittings	40
2012 GWHZ	Zerk Fittings	40

Because of the health hazards associated with contamination and lead content in drinking water systems, Dixon couplings, unless otherwise specifically approved, are not recommended for potable water service and should not be used in applications where drinking water will contact the wetted surfaces of the couplings.

D.O.T. AIR BRAKE FITTINGS - RUBBER AIR HOSE

NEW 56RBSG	Spring	55
NEW 60RB	Sleeve.....	55
NEW 61RB	Nut	55
61RBSG	Spring Guard Nut.....	55
67RBSG	Air Brake Hose Nut & Attached Spring	55
68RB	Male Connector Body Only	56
68RBSG	Male Connector with Spring Guard.....	56

In order to better serve you, Dixon Brass continues to produce non-catalog sizes and products on a special quote / delivery basis. Please contact your sales representative for further details.

Standard Hose Fittings

**How to Use
Dixon Brass
Standard Hose Fitting
Part Numbers**

1020406C

1020406C

1020406C

1020406C

SERIES IDENTIFICATION

HOSE I.D. (Measured in sixteenths of an inch)

THREAD SIZE (Measured in sixteenths of an inch)

MATERIAL/THREAD TYPE

Dixon Brass offers over 180 standard hose fittings in 20 different series. All standard hose fittings are intended for use with hose clamps or crimped ferrules.

All standard hose fittings are machined from free cutting brass alloys CDA, 360 and 377 and stainless steel alloys 316, 303 or 304.

102 Series

102-SS Series Type 316 stainless

102-BSPT Series British Standard Pipe Tapered

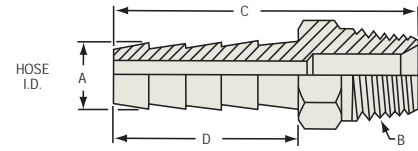

NPTF- MALE HOSE BARB

National Pipe Tapered - Dryseal

Standard Brass Part Number	SS	BSPT	Hose ID A	NPTF ** Thread B	Length C	Hex	Number of Barbs	Barb Length D	Std. Pkg.	Lbs. per 100 pcs.
1020202C	SS		1/8	1/8-27	1.06	7/16	3	.46	100 *	1.8
1020204C				1/4-18	1.16	9/16	3	.46	100	3.1
1020302C	SS		3/16	1/8-27	1.35	7/16	3	.75	100 *	2.2
1020304C	SS			1/4-18	1.54	9/16	3	.75	100 *	4.0
1020402C	SS	BSPT		1/8-27	1.57	1/2	4	.97	100 *	2.9
1020404C	SS	BSPT	1/4	1/4-18	1.76	9/16	4	.97	100 *	4.3
1020406C	SS			3/8-18	1.76	11/16	4	.97	100 *	5.4
1020408C				1/2-14	1.97	7/8	4	.97	50	13.8
1020502C	SS		5/16	1/8-27	1.57	1/2	4	.97	100 *	2.9
1020504C	SS			1/4-18	1.76	9/16	4	.97	50 *	4.3
1020506C	SS			3/8-18	1.76	11/16	4	.97	50 *	5.6
1020602C	SS			1/8-27	1.57	1/2	4	.97	100 *	3.8
1020604C	SS	BSPT		1/4-18	1.76	9/16	4	.97	100 *	4.8
1020606C	SS	BSPT	3/8	3/8-18	1.76	11/16	4	.97	50 *	6.1
1020608C	SS	BSPT		1/2-14	1.97	7/8	4	.97	25 *	10.8
1020612C				3/4-14	1.97	1-1/16	4	.97	25	14.9
1020804C	SS		1/2	1/4-18	1.76	5/8	4	.97	50 *	6.7
1020806C	SS	BSPT		3/8-18	1.76	11/16	4	.97	50 *	6.9
1020808C	SS	BSPT		1/2-14	1.97	7/8	4	.97	25 *	12.0
1020812C	SS			3/4-14	1.97	1-1/16	4	.97	25 *	15.7
1021006C	SS		5/8	3/8-18	1.76	11/16	4	.97	50 *	7.8
1021008C	SS			1/2-14	1.97	7/8	4	.97	25 *	11.6
1021012C	SS			3/4-14	1.97	1-1/16	4	.97	25 *	15.7
1021208C	SS		3/4	1/2-14	2.19	7/8	4	1.19	25 *	16.4
1021212C	SS	BSPT		3/4-14	2.19	1-1/16	4	1.19	25 *	18.0
1021612C	SS		1	3/4-14	2.19	1-1/16	5	1.19	20 *	25.0
1021616C		BSPT		1-11-1/2+	2.54	1-3/8	5	1.19	10 *	37.1
1022012C			1-1/4	3/4-14	2.37	1-3/8	5	1.19	10	38.7
1022016C				1-11-1/2+	2.54	1-3/8	5	1.19	5	46.9

* 102-SS and 102-BSPT are packaged to order

** NPT thread on 102-SS

+ capped

NPTF- MALE SWIVEL HOSE BARB
National Pipe Tapered - Dryseal

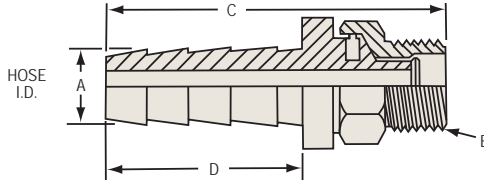

Part Number	Hose ID A	NPTF Thread B	Length C	Hex	Number of Barbs	Barb Length D	Std. Pkg.	Lbs. per 100 pcs.
1030402C	1/4	1/8-27	2.19	9/16	4	.97	100	3.5
1030404C		1/4-18	2.12	9/16	4	.97	100	6.0
1030604C	3/8	1/4-18	2.12	9/16	4	.97	100	6.6
1030606C		3/8-18	2.12	11/16	4	.97	50	8.4
1030806C	1/2	3/8-18	2.12	11/16	4	.97	50	9.7
1030808C		1/2-14	2.33	7/8	4	.97	25	14.1
1031212C	3/4	3/4-14	2.33	1-1/16	4	.97	25	20.7
1031616C	1	1-11-1/2 +	3.43	1-3/8	5	1.19	10	40.0

Note: Swivel for assembly convenience only.
+ capped threads / 150 maximum PSI

NPTF- FEMALE HOSE BARB - SOLID
National Pipe Tapered - Dryseal

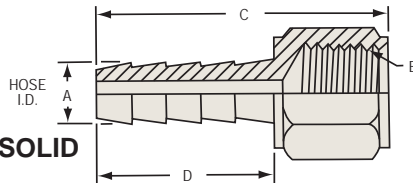

Part Number	303 SS	Hose ID A	NPTF ** Thread B	Length C	Hex	Number of Barbs	Barb Length D	Std. Pkg.	Lbs. per 100 pcs.
1040202C		1/8	1/8-27	.96	1/2	3	.46	100	2.1
1040204C			1/4-18	1.15	5/8	3	.46	100	4.0
1040302C		3/16	1/8-27	1.25	1/2	3	.75	100	2.4
1040304C			1/4-18	1.44	5/8	3	.75	100	4.3
1040402C	SS	1/4	1/8-27	1.47	1/2	4	.97	100	2.8
1040404C			1/4-18	1.66	5/8	4	.97	100 *	4.6
1040406C			3/8-18	1.66	3/4	4	.97	50	5.6
1040408C			1/2-14	1.66	15/16	4	.97	50	8.1
1040502C		5/16	1/8-27	1.47	9/16	4	.97	100	3.6
1040504C			1/4-18	1.66	5/8	4	.97	100	4.7
1040506C			3/8-18	1.66	3/4	4	.97	50	5.7
1040602C	SS	3/8	1/8-27	1.47	9/16	4	.97	100	4.2
1040604C			1/4-18	1.66	5/8	4	.97	50 *	5.4
1040606C	SS	3/8	3/8-18	1.66	3/4	4	.97	50 *	6.3
1040608C	SS	1/2	1/2-14	1.66	15/16	4	.97	50	8.8
1040612C			3/4-14	1.97	1-3/16	4	.97	25	20.6
1040804C			1/4-18	1.66	5/8	4	.97	50	6.2
1040806C			3/8-18	1.66	3/4	4	.97	50	7.3
1040808C	SS	1/2	1/2-14	1.66	15/16	4	.97	50 *	9.3
1040812C			3/4-14	1.97	1-3/16	4	.97	25 *	25.8
1041006C		5/8	3/8-18	1.66	3/4	4	.97	50 *	7.5
1041008C			1/2-14	1.66	3/4	4	.97	25 *	10.0
1041012C			3/4-14	1.97	1-3/16	4	.97	25 *	20.6
1041208C		3/4	1/2-14	1.88	15/16	4	1.19	25 *	12.5
1041212C			3/4-14	2.19	1-3/16	4	1.19	20 *	22.6
1041612C		1	3/4-14	2.19	1-3/16	5	1.19	20 *	26.1
1041616C			1-11-1/2	2.32	1-3/16	5	1.19	10 *	34.7
1042016C		1-1/4	1-11-1/2	2.32	1-7/16	5	1.19	10	43.7

* 104-SS are packaged to order

** NPT thread on 104-SS

105 Series

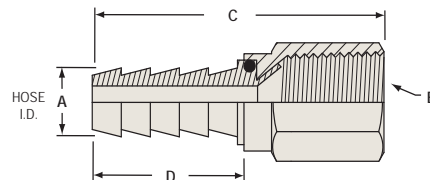

NPTF - FEMALE SWIVEL HOSE BARB

National Pipe Tapered - Dryseal

Part Number	Hose ID A	NPTF Thread B	Over All Length C	Hex	Number of Barbs	Barb Length D	Std. Pkg.	Lbs. per 100 pcs.
1050404C	1/4	1/4-18	1.80	5/8	4	.97	100	5.6
1050604C	3/8	1/4-18	1.80	5/8	4	.97	50	6.2
1050606C		3/8-18	1.82	3/4	4	.97	50	8.7
1050806C	1/2	3/8-18	1.82	3/4	4	.97	50	8.7
1050808C		1/2-14	1.86	15/16	4	.97	50	14.3

Note: Swivel for assembly convenience only.

124 Series

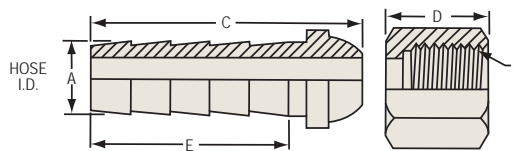

NPSM - FEMALE SWIVEL HOSE BARB

National Pipe Straight - Ball Seat Type

Part Number	Hose ID A	NPSM Thread B	Stem Length C	Nut Length D	Hex	Number of Barbs	Barb Length E	Std. Pkg.	Lbs. per 100 pcs.
1240202K	1/8	1/8-27	.79	.44	1/2	3	.46	100	2.3
1240302K	3/16	1/8-27	1.08	.44	1/2	3	.75	100	2.6
1240304K		1/4-18	1.17	.53	5/8	3	.75	100	4.5
1240402K	1/4	1/8-27	1.30	.44	1/2	4	.97	100	3.0
1240404K		1/4-18	1.39	.53	5/8	4	.97	100	4.8
1240406K	5/16	3/8-18	1.41	.63	3/4	4	.97	100	6.7
1240504K		1/4-18	1.39	.53	5/8	4	.97	100	5.0
1240506K	3/8-18	1.41	.63	3/4	4	.97	50	6.6	
1240604K	3/8	1/4-18	1.37	.53	5/8	4	.97	100	4.9
1240606K		3/8-18	1.45	.63	3/4	4	.97	100	7.1
1240608K	1/2	1/2-14	1.54	.69	15/16	4	.97	100	12.4
1240806K		3/8-18	1.42	.63	3/4	4	.97	50	7.5
1240808K	1/2-14	1.54	.69	15/16	4	.97	100	12.7	
1241212K	3/4	3/4-14	1.69	.75	1-1/8	4	1.19	50	17.4

126 Series

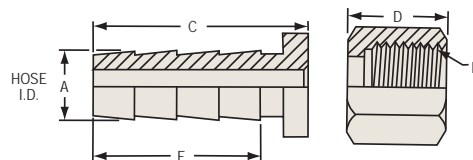

NPSM - FEMALE SWIVEL HOSE BARB

National Pipe Straight - Gasket Seat Type

Part Number	Hose ID A	NPSM Thread B	Stem Length C	Nut Length D	Hex	Number of Barbs	Barb Length E	Std. Pkg.	Lbs. per 100 pcs.
1260202C	1/8	1/8-27	.69	.44	1/2	3	.46	100	2.2
1260302C	3/16	1/8-27	.98	.44	1/2	3	.75	100	2.5
1260304C		1/4-18	.98	.53	5/8	3	.75	100	4.0
1260402C	1/4	1/8-27	1.20	.44	1/2	4	.97	100	2.7
1260404C		1/4-18	1.20	.53	5/8	4	.97	100	4.3
1260406C	5/16	3/8-18	1.22	.63	3/4	4	.97	100	6.0
1260504C		1/4-18	1.20	.53	5/8	4	.97	100	4.2
1260604C	3/8	1/4-18	1.20	.53	5/8	4	.97	100	4.6
1260606C		3/8-18	1.22	.63	3/4	4	.97	50	6.4
1260608C	1/2	1/2-14	1.22	.69	15/16	4	.97	50	10.4
1260806C		3/8-18	1.22	.63	3/4	4	.97	50	7.0
1260808C	1/2-14	1.22	.69	15/16	4	.97	50	11.0	
1261212C	3/4	3/4-14	1.47	.75	1-1/8	4	1.19	25	15.6

Not recommended with water

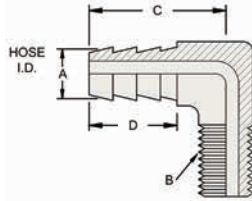

90° ELBOW- Forged
Hose Barb to Male PTF

Part Number	Hose ID A	PTF Thread B	Length Centerline C	Number of Barbs	Barb Length D	Std. Pkg.	Lbs. per 100 pcs.
1290302C	3/16	1/8-27	1.05	3	.79	50	3.3
1290402C		1/8-27	1.05	3	.79	50	3.4
1290404C	1/4	1/4-18	1.14	3	.79	50	6.2
1290406C		3/8-18	1.16	3	.79	50	7.3
1290502C		1/8-27	1.05	3	.79	25	3.1
1290504C	5/16	1/4-18	1.14	3	.79	50	6.1
1290506C		3/8-18	1.16	3	.79	50	6.5
1290602C		1/8-27	1.09	3	.87	50	3.6
1290604C	3/8	1/4-18	1.14	3	.87	50	6.6
1290606C		3/8-18	1.22	3	.87	50	8.9
1290608C		1/2-14	1.29	3	.87	25	13.1
1290804C		1/4-18	1.17	3	.87	50	6.3
1290806C	1/2	3/8-18	1.24	3	.87	50	8.3
1290808C		1/2-14	1.29	3	.87	25	12.3
1291006C	5/8	3/8-18	1.31	3	.87	25	17.2
1291008C		1/2-14	1.36	3	.87	25	18.6
1291208C	3/4	1/2-14	1.36	3	.87	25	23.2
1291212C		3/4-14	1.44	3	.87	25	21.5
1291612C	1	3/4-14	1.65	4	.98	10	37.1
1291616C		1-11-1/2 +	1.69	4	.98	10	42.5

+ Capped

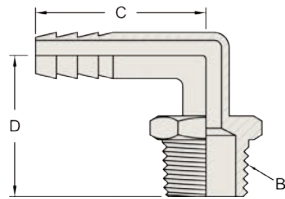

129-SS (316 stainless) Series



90° ELBOW - Casting
Hose Barb to Male NPT

Part Number	Hose ID A	NPT Thread B	Length Centerline C	Number of Barbs	Height Centerline D	Lbs. per 100 pcs.
1290404SS	1/4	1/4-18	1.47	4	1.024	7.0
1290604SS		1/4-18	1.18	3	1.024	7.4
1290606SS	3/8	3/8-18	1.42	3	1.180	9.3
1290808SS	1/2	1/2-14	1.69	4	1.500	12.6
1291212SS	3/4	3/4-14	2.08	4	1.897	21.7

129-SS parts are packaged to order

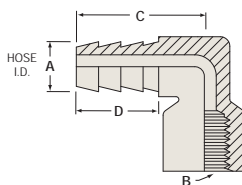

134 Series



90° ELBOW- Forged
Hose Barb to Female PTF

Part Number	Hose ID A	PTF Thread B	Length Centerline C	Number of Barbs	Barb Length D	Std. Pkg.	Lbs. per 100 pcs.
1340402C		1/8-27	1.05	3	.79	50	6.9
1340404C	1/4	1/4-18	1.14	3	.79	50	8.1
1340604C	3/8	1/4-18	1.14	3	.79	50	9.4
1340606C		3/8-18	1.22	3	.79	50	12.5
1340804C		1/4-18	1.17	3	.87	25	9.4
1340806C	1/2	3/8-18	1.24	3	.89	25	12.5
1340808C		1/2-14	1.29	3	.87	25	28.1
1341212C	3/4	3/4-14	1.52	3	.97	25	50.1

139 Series

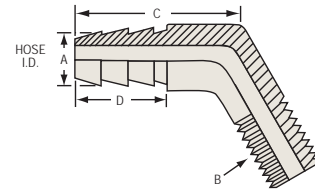

45° ELBOW- Forged
Hose Barb to Male PTF

Part Number	Hose ID A	PTF Thread B	Length Centerline C	Number of Barbs	Barb Length D	Std. Pkg.	Lbs. per 100 pcs.
1390402C	1/4	1/8-27	.96	3	.79	100	3.4
1390404C		1/4-18	1.01	3	.79	25	6.2
1390602C	3/8	1/8-27	1.03	3	.87	100	3.6
1390604C		1/4-18	1.05	3	.87	100	6.6
1390606C		3/8-18	1.10	3	.87	25	8.9
1390804C	1/2	1/4-18	1.10	3	.87	25	6.3
1390806C		3/8-18	1.10	3	.87	25	8.3
1390808C		1/2-14	1.15	3	.87	50	12.3
1391208C		3/4	1/2-14	1.15	3	.87	25

142 Series

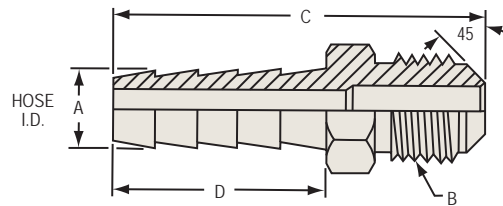

MALE HOSE BARB
45° SAE

Part Number	Hose ID A	Tube OD	UNF Thread B	Length C	Hex	Number of Barbs	Barb Length D	Std. Pkg.	Lbs. per 100 pcs.
1420307C	3/16	1/4	7/16-20	1.50	7/16	3	.75	100	2.7
1420407C	1/4	1/4	7/16-20	1.72	7/16	4	.97	100	3.2
1420410C		3/8	5/8-18	1.82	5/8	4	.97	100	6.6
1420508C	5/16	5/16	1/2-20	1.75	1/2	4	.97	100	4.5
1420610C	3/8	3/8	5/8-18	1.82	5/8	4	.97	50	7.6
1420612C		1/2	3/4-16	1.97	3/4	4	.97	50	9.9
1420812C		1/2	1/2	3/4-16	1.97	3/4	4	.97	50

143 Series

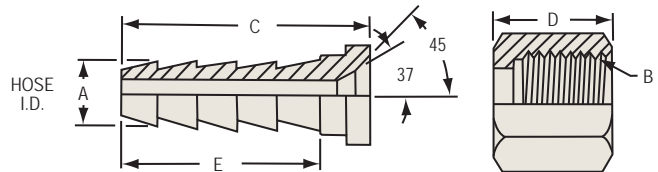

FEMALE SWIVEL HOSE BARB
45° SAE / 37° JIC (Dual Angle Seat)

Part Number	Hose ID A	Tube OD	UNF Thread B	Stem Length C	Nut Length D	Hex	Number of Barbs	Barb Length E	Std. Pkg.	Lbs. per 100 pcs.
1430307K	3/16	1/4	7/16-20	1.03	.60	9/16	3	.75	100	3.8
1430407K	1/4	1/4	7/16-20	1.25	.60	9/16	4	.97	100	4.1
1430408K		5/16	1/2-20	1.31	.68	5/8	4	.97	100	5.1
1430508K	5/16	5/16	1/2-20	1.31	.68	5/8	4	.97	100	5.1
1430612K	3/8	1/2	3/4-16	1.34	.84	7/8	4	.97	100	10.2
1430812K	1/2	1/2	3/4-16	1.34	.84	7/8	4	.97	100	10.9
1430814K		5/8	7/8-14	1.34	.96	1-1/16	4	.97	50	17.7

144 Series

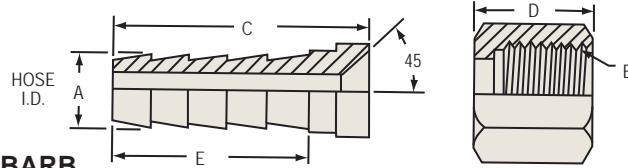

FEMALE SWIVEL HOSE BARB
45° SAE

Part Number	Hose ID A	Tube OD	UNF Thread B	Stem Length C	Nut Length D	Hex	Number of Barbs	Barb Length E	Std. Pkg.	Lbs. per 100 pcs.
1440306K	3/16	3/16	3/8-24	1.03	.45	7/16	3	.75	100	2.0
1440410K	1/4	3/8	5/8-18	1.27	.68	3/4	4	.97	100	6.7
1440510K	5/16	3/8	5/8-18	1.27	.68	3/4	4	.97	100	6.7
1440610K	3/8	3/8	5/8-18	1.27	.68	3/4	4	.97	100	7.2
1440812K	1/2	1/2	3/4-16	1.34	.84	7/8	4	.97	100	10.9
1441217K	3/4	3/4	1-1/16 - 14	1.47	1.03	1-1/4	4	.97	25	19.9

145 Series

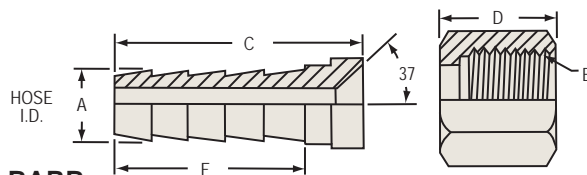

FEMALE SWIVEL HOSE BARB
37° JIC

Part Number	Hose ID A	Tube OD	UNF Thread B	Stem Length C	Nut Length D	Hex	Number of Barbs	Barb Length E	Std. Pkg.	Lbs. per 100 pcs.
1450609K	3/8	3/8	9/16-18	1.24	.63	11/16	4	.97	100	6.0
1451217K	3/4	3/4	1-1/16 - 12	1.47	1.03	1-1/4	4	.97	25	19.9

177 Series

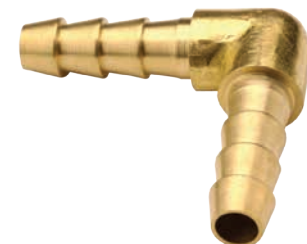
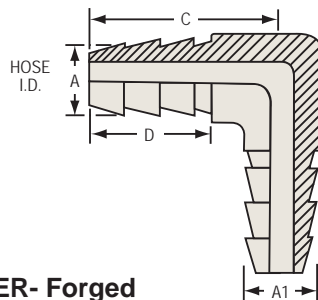

HOSE BARB 90° ELBOW SPLICER- Forged

Part Number	Hose ID A	Hose ID A1	Length Centerline C	Number of Barbs	Barb Length D	Std. Pkg.	Lbs. per 100 pcs.
1770202C	1/8	1/8	.73	3	.46	25	2.5
1770303C	3/16	3/16	1.05	3	.79	25	3.1
1770402C	1/4	1/8	1.05	3	.79	25	3.1
1770404C		1/4	1.05	3	.79	25	3.0
1770505C	5/16	5/16	1.15	3	.79	25	4.9
1770604C	3/8	1/4	1.15	3	.79	25	6.2
1770606C		3/8	1.15	3	.79	25	5.0
1770806C	1/2	3/8	1.25	3	.87	25	8.7
1770808C		1/2	1.25	3	.87	25	9.3
1771010C	5/8	5/8	1.30	3	.87	25	15.6
1771208C	3/4	1/2	1.41	3	.89	25	20.6
1771212C		3/4	1.41	3	.89	25	20.6

177-SS (304 stainless) Series

2012

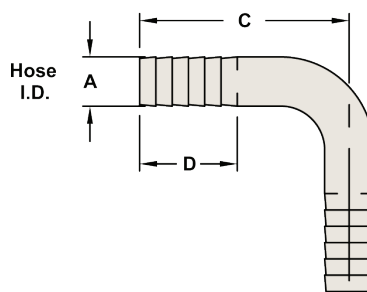

HOSE BARB 90° ELBOW SPLICER

Part Number	Hose ID A	Barb Length D	Length Centerline C	Number of Barbs	Lbs. per 100 pcs.
1770202SS	1/8	.36	.85	3	0.6
1770303SS	3/16	.54	1.68	5	1.9
1770404SS	1/4	.54	1.14	5	2.5
1770606SS	3/8	.56	1.46	5	4.0
1770808SS	1/2	.58	2.24	5	8.2

177-SS parts are packaged to order

178 and 178-SS (316 stainless) Series

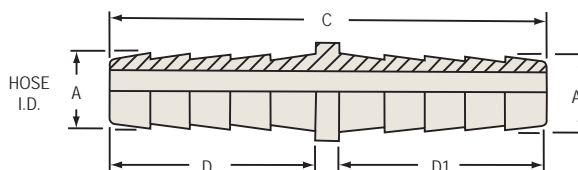

HOSE SPLICER

Part Number	SS	Hose ID A	Hose ID A1	Length C	Number of Barbs	Barb Length D	Barb Length D1	Std. Pkg.	Lbs. per 100 pcs.
1780202C		1/8	1/8	.97	3	.46	.46	100	0.6
1780303C		3/16	3/16	1.56	3	.75	.75	100	1.3
1780402C		1/4	1/8	1.55	4	.97	.46	100	2.0
1780404C	SS	1/4	1/4	2.03	4	.97	.97	100 *	2.3
1780505C		5/16	5/16	2.06	4	.97	.97	100	2.5
1780604C		3/8	1/4	2.06	4	.97	.97	100	3.7
1780606C	SS	3/8	3/8	2.06	4	.97	.97	100 *	4.0
1780806C		1/2	3/8	2.06	4	.97	.97	50	6.2
1780808C	SS	1/2	1/2	2.06	4	.97	.97	50 *	6.5
1781006C			3/8	2.06	4	.97	.97	50	6.2
1781008C		5/8	1/2	2.06	4	.97	.97	50	6.8
1781010C			5/8	2.06	4	.97	.97	50	7.0
1781208C		3/4	1/2	2.28	4	1.19	.97	25	10.6
1781212C	SS	3/4	3/4	2.50	4	1.19	1.19	25 *	12.8
1781616C		1	1	3.00	5	1.44	1.44	10	22.5

* 178-SS packaged to order

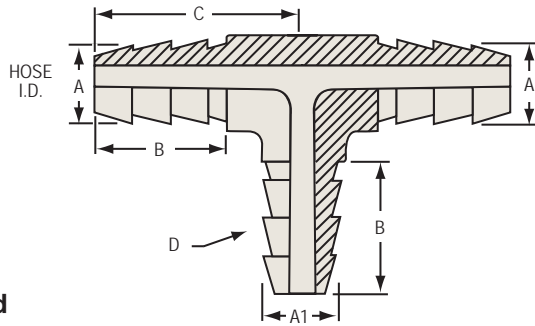

**HOSE BARB- Forged
TEE SPLICER**

Part Number	Hose ID A	Hose ID A1	Barb Length B	Length Centerline C	NPTF Thread D	Number of Barbs	Std. Pkg.	Lbs. per 100 pcs.
1790202C	1/8	1/8	.46	.69	--	3	25	3.1
1790303C	3/16	3/16	.71	.94	--	3	100	3.1
1790402C	1/4	1/8	.46	.94	--	3	25	4.4
1790404C		1/4	.71	.94	--	3	25	3.4
1790505C	5/16	5/16	.83	1.18	--	3	25	6.4
1790604C *	3/8	--	.90	1.26	1/4-18	3	25	11.2
1790606C		3/8	.86	1.26	--	3	25	8.0
1790806C	1/2	3/8	.90	1.26	--	3	25	10.0
1790808C		1/2	.90	1.26	--	3	25	10.4
1791010C	5/8	5/8	.90	1.33	--	3	25	15.8
1791208C	3/4	1/2	.90	1.41	--	3	25	22.5
1791212C		3/4	.90	1.41	--	3	20	37.0

* 1790604C not pictured

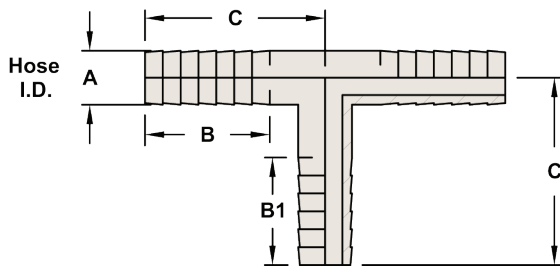

179-SS (304 stainless) Series



2012

**HOSE BARB
TEE SPLICER**

Part Number	Hose ID A	Barb Length B	Barb Length B 1	Length Centerline C	Number of Barbs	Lbs. per 100 pcs.
1790202SS	1/8	.50	.50	.62	4	1.3
1790303SS	3/16	.56	.56	.70	5	1.5
1790404SS	1/4	.63	.56 *	.94	6 / 5 *	2.5
1790606SS	3/8	.55	.55	1.01	5	3.2
1790808SS	1/2	.59	.55	1.01	5	5.6

* On Drop - 5 Barbs

179-SS parts are packaged to order

Welding Hose Fittings

Features:

- Dixon Brass offers 16 welding hose fitting in 4 different series.
- Our welding hose fittings are manufactured to exacting specifications.
- All welding hose fittings are packaged for easy storage and identification. Female swivel welding hose fittings (152 and 154 series) are sold in stem and swivel nut sets. Pricing information on separate components is available upon request.
- It is recommended that hose assemblies be fabricated using hose clamps or crimped ferrules in conjunction with hose barbs.

The following letter size designations are commonly used for both oxygen and fuel gas fitting size identification:

A-Size 3/8-24 UNF
B-Size 9/16-18 UNF

152 Series

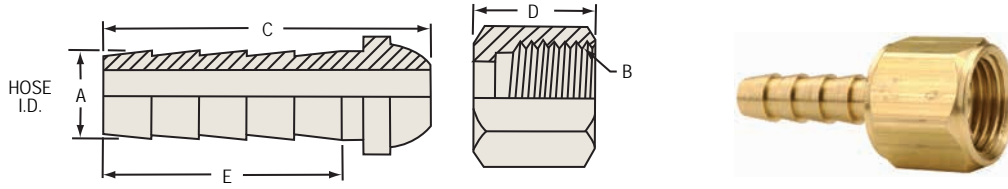

WELDING HOSE COUPLING

Right Hand Thread for Oxygen Line

Part Number	Hose ID A	Right UNF Thread B	Stem Length C	Nut Length D	Hex	Number of Barbs	Barb Length E	Std. Pkg.	Lbs. per 100 pcs.
1520306K	3/16	3/8-24	1.32	.45	7/16	4	.97	100	2.3
1520309K		9/16-18	1.43	.63	11/16	4	.97	100	6.1
1520409K	1/4	9/16-18	1.43	.63	11/16	4	.97	100	6.2
1520509K	5/16	9/16-18	1.43	.63	11/16	4	.97	100	6.6
1520609K	3/8	9/16-18	1.43	.63	11/16	4	.97	100	6.9

154 Series

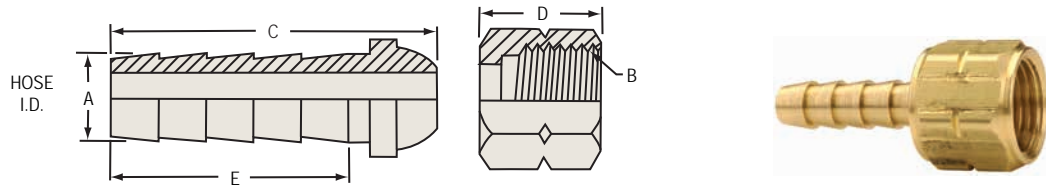

WELDING HOSE COUPLING

Left Hand Thread for Acetylene Line

Part Number	Hose ID A	Right UNF Thread B	Stem Length C	Nut Length D	Hex	Number of Barbs	Barb Length E	Std. Pkg.	Lbs. per 100 pcs.
1540306K	3/16	3/8-24	1.32	.45	7/16	4	.97	100	2.3
1540309K		9/16-18	1.43	.63	11/16	4	.97	100	6.1
1540409K	1/4	9/16-18	1.43	.63	11/16	4	.97	100	6.2
1540509K	5/16	9/16-18	1.43	.63	11/16	4	.97	100	6.6
1540609K	3/8	9/16-18	1.43	.63	11/16	4	.97	100	6.9

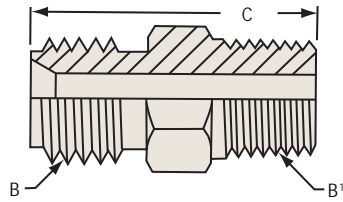

WELDING HOSE ADAPTER

Right Hand Thread

Part Number	Right UNF Thread B	NPTF Thread B'	Length C	Hex	Std. Pkg.	Lbs. per 100 pcs.
1560904C	9/16-18	1/4-18	1.30	5/8	100	5.8
1560906C	9/16-18	3/8-18	1.30	11/16	50	8.9
1560909C	9/16-18	9/16-18 *	1.25	11/16	100	6.9

* *Right UNF thread*

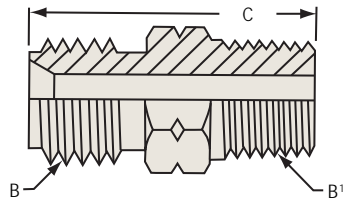

WELDING HOSE ADAPTER

Left Hand Thread

Part Number	Left UNF Thread B	NPTF Thread B'	Length C	Hex	Std. Pkg.	Lbs. per 100 pcs.
1580904C	9/16-18	1/4-18	1.30	5/8	100	5.8
1580906C	9/16-18	3/8-18	1.30	11/16	50	8.9
1580909C	9/16-18	9/16-18 *	1.25	11/16	100	6.9

* *Left UNF thread*

Brass Ferrules and Crimping Tool

200 Series

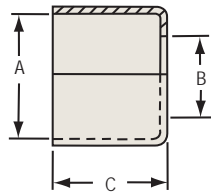

STAMPED BRASS FERRULE

Part Number	Reference No.	Ferrule ID A	Ferrule Length C	Hole Size B	Gauge	Std. Pkg. *	Lbs. per 100 pcs.
2004000C	619	.400	.47	.27	.020	100	.40
2004530C	769	.450	.56	.34	.016	50	.44
2004750C	4750	.478	.69	.33	.024	50	.76
2005000C	624	.500	.50	.34	.016	50	.40
2005005C	7322	.500	1.00	.34	.024	50	1.20
2005250C	625	.525	.50	.34	.016	50	.42
2005255C	7323	.525	1.00	.38	.024	50	1.18
2005310C	7324	.531	1.00	.44	.024	50	1.20
2005500C	626	.550	.48	.38	.016	50	.42
2005620C	7325	.562	1.00	.44	.024	50	1.28
2005930C	7326	.593	1.00	.44	.024	50	1.34
2006250C	II	.625	.50	.50	.019	50	.58
2006255C	7327	.625	1.00	.44	.024	50	1.44
2006500C	HH	.650	.50	.50	.019	50	.60
2006560C	7328	.656	1.00	.44	.024	50	1.48
2006750C	GG	.675	.52	.50	.019	100	.86
2006900C	7329	.687	1.00	.50	.024	50	1.52
2007180C	7330A	.718	1.00	.63	.024	50	1.62
2007250C	EE	.725	.53	.50	.019	50	.76
2007500C	DD	.750	.53	.50	.019	50	.96
2007505C	7331	.750	1.00	.63	.024	50	1.74
2007750C	CC	.775	.53	.50	.016	50	.90
2007810C	7332	.781	1.00	.63	.024	50	1.84
2008120C	7333	.812	1.00	.63	.024	50	1.94
2008750C	7244A	.875	.84	.69	.024	25	1.66
2009250C	7113	.925	.84	.69	.025	50	1.86
2009750C	5028A	.975	.84	.69	.024	25	1.96
2009950C	7104A	1.150	.84	.88	.024	50	2.36
2001025C	7114A	1.025	.84	.69	.024	25	2.40
2001100C	5027	1.100	.84	.81	.023	25	2.40
2001175C	7088A	1.175	.84	.88	.024	25	2.50
2001225C	875K	1.225	.875	.875	.025	25	2.50
2001500C	1500	1.500	.875	1.12	.025	25	3.50

* Sold in full bag quantity only



200FC FERRULE CRIMPING TOOL

Standard Die Part Number	Bore Die *	Hose OD **
200FC6A	.625	.640 - .671
200FC5	.578	.590 - .625
200FC4B	.531	.540 - .562
200FC4A	.484	.490 - .520
200FC6B	.687	.690 - .710

Features:

- Professional quality ferrule crimper provides fixed mount production capability or job-site portability
- Shipped with 5 standard die sets for 1/4" single braid hose through 3/8" 2-braid hose
- Optional die sets available for 3/16" and 1/2" hoses

Optional Die Part Number	Bore Die *	Hose OD **
200FC3	.375	.385 - .406
200FC8A	.750	.760 - .781
200FC8B	.812	.820 - .843

* See ferrule ID above

** Diameter with barbed insert installed

Re-usable Hose Fittings

Applications:

Reusable fittings are used when a more durable hose connection is required or ease of making a repair is a major consideration.

Features:

- Dixon Brass offers over 110 re-usable fittings in 10 different series.
- All re-usable fittings are of heavy duty construction.

Three variables must be determined before ordering.

1. I.D. of hose to be used with fitting
2. O.D. of hose to be used with fitting
3. Connection thread size desired

Part number for re-usable hose fitting sets (183, 185 and 187) series are easy to understand and use. The first three digits of the seven digit part number signify a specific product series. The fourth digit signifies the hose I.D. used with the fitting (measured in sixteenths of an inch). The fifth and sixth digits signify the hose O.D. used with the fitting (measured in sixteenths of an inch).

Note: Recommended for rubber covered hose only.

How to Use Dixon Brass Reusable Hose Fitting Part Numbers

1836116

SERIES IDENTIFICATION

1836116

HOSE I.D. (Measured in sixteenths of an inch)

1836116

HOSE O.D. (Measured in sixteenths of an inch)

1836116

THREAD SIZE (Measured in sixteenths of an inch)

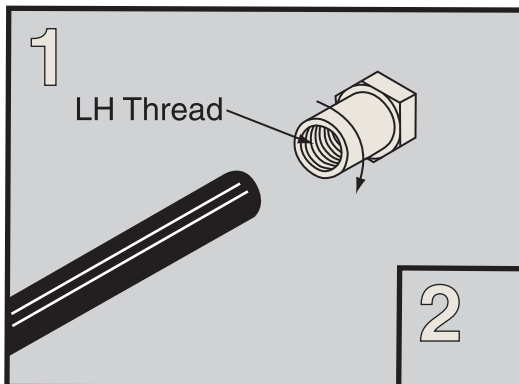

Simply slip and twist ferrule on end of hose which has been trimmed flush. No skiving necessary.

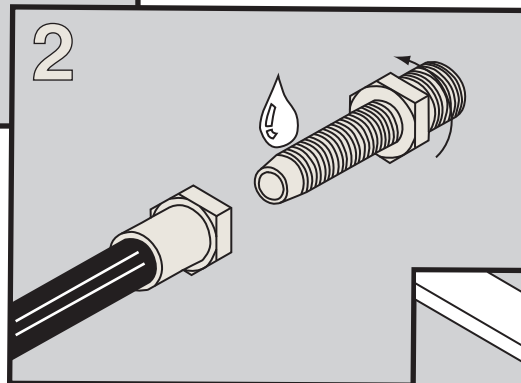

Apply a drop or two of lubricant to fitting before inserting ferrule.

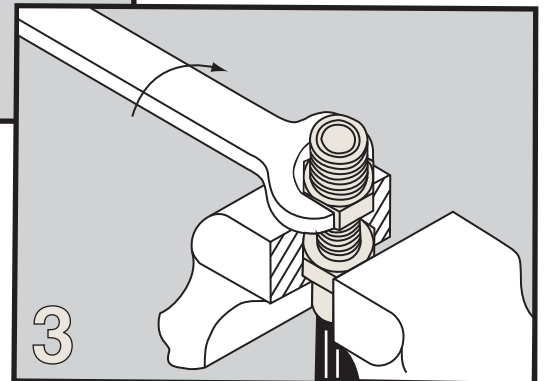

Turn reusable fitting into ferrule. Hose is expanded inside ferrule for perfect fit.

How to Install Reusable Fittings without Skiving or Crimping

180 and 180-SS Series

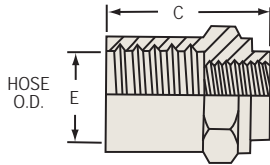

REUSABLE FERRULE

Standard Brass Part Number	303 SS	Hose ID	Hose OD E	Length C	Hex	Std. Pkg.	Lbs. per 100 pcs.
1800408F	SS		1/2	1.02	11/16	100 *	5.3
1800409F	SS	1/4	9/16	1.02	3/4	50 *	6.3
1800410F	SS		5/8	1.02	13/16	50 *	7.3
1800509F	SS		9/16	1.10	3/4	100 *	6.6
1800510F	SS	5/16	5/8	1.10	13/16	50 *	7.8
1800511F	SS		11/16	1.10	7/8	50	8.6
1800610F	SS		5/8	1.10	13/16	50 *	7.2
1800611F	SS	3/8	11/16	1.10	7/8	50 *	8.3
1800612F	SS		3/4	1.10	7/8	50 *	6.7
1800814F	SS		7/8	1.69	1-1/16	25 *	15.8
1800815F	SS	1/2	15/16	1.69	1-1/8	25 *	17.5
1800816F	SS		1	1.69	1-3/16	20	19.5

* 180-SS packaged to order

182 and 182-SS Series

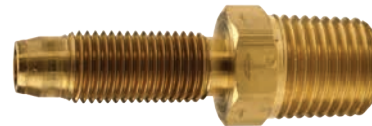
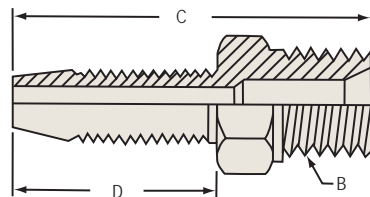

REUSABLE MALE STEM

Standard Brass Part Number	303 SS	Hose ID	NPTF ** Thread B	Length C	Stem Length D	Hex	Std. Pkg.	Lbs. per 100 pcs.
1820402S	SS		1/8-27	1.68	1.07	9/16	100 *	4.1
1820404S	SS	1/4	1/4-18	1.86	1.07	9/16	100 *	5.1
1820406S	SS		3/8-18	1.86	1.07	11/16	50	6.5
1820504S	SS	5/16	1/4-18	1.96	1.17	9/16	50 *	5.5
1820506S	SS		3/8-18	1.96	1.17	11/16	50	6.9
1820604S	SS		1/4-18	1.96	1.17	9/16	100 *	6.4
1820606S	SS	3/8	3/8-18	1.96	1.17	11/16	50 *	7.8
1820608S	SS		1/2-14	2.17	1.17	7/8	25	12.7
1820804S	SS		1/4-18	2.43	1.64	11/16	50	12.3
1820806S	SS	1/2	3/8-18	2.43	1.64	11/16	50 *	11.0
1820808S	SS		1/2-14	2.64	1.64	7/8	25 *	16.3

* 182-SS packaged to order

** NPT thread on 182-SS

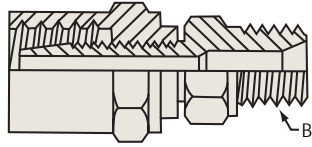
**REUSABLE MALE FITTING - UNASSEMBLED**

Standard Brass Part Number	303 SS	Hose ID	Hose OD	NPTF ** Thread B	Stem Hex	Ferrule Hex	Std. Pkg.	Lbs. per 100 pcs.
1834082K	SS		1/2	1/8-27	9/16	11/16	100 *	9.4
1834092K	SS	1/4	9/16	1/8-27	9/16	3/4	100 *	10.5
1834102K	SS		5/8	1/8-27	9/16	13/16	100 *	11.4
1834084K	SS		1/2	1/4-18	9/16	11/16	50 *	10.4
1834094K	SS	1/4	9/16	1/4-18	9/16	3/4	50 *	11.4
1834104K	SS		5/8	1/4-18	9/16	13/16	50 *	12.3
1834086K			1/2	3/8-18	11/16	11/16	50	11.8
1834096K		1/4	9/16	3/8-18	11/16	3/4	50	12.8
1834106K			5/8	3/8-18	11/16	13/16	50	13.8
1835094K	SS		9/16	1/4-18	9/16	3/4	50 *	12.1
1835104K	SS	5/16	5/8	1/4-18	9/16	13/16	50 *	13.4
1835114K			11/16	1/4-18	9/16	7/8	50	14.1
1835096K			9/16	3/8-18	11/16	3/4	50	13.5
1835106K		5/16	5/8	3/8-18	11/16	13/16	50	14.7
1835116K			11/16	3/8-18	11/16	7/8	50	15.5
1836104K	SS		5/8	1/4-18	9/16	13/16	50 *	13.6
1836114K	SS	3/8	11/16	1/4-18	9/16	7/8	50 *	14.7
1836124K	SS		3/4	1/4-18	9/16	7/8	50 *	13.1
1836106K	SS		5/8	3/8-18	11/16	13/16	50 *	15.0
1836116K	SS	3/8	11/16	3/8-18	11/16	13/16	50 *	16.1
1836126K	SS		3/4	3/8-18	11/16	7/8	50 *	14.6
1836108K			5/8	1/2-14	7/8	13/16	50	19.9
1836118K		3/8	11/16	1/2-14	7/8	7/8	50	21.0
1836128K			3/4	1/2-14	7/8	7/8	50	19.4
1838144K			7/8	1/4-18	11/16	1-1/16	25	28.1
1838154K		1/2	15/16	1/4-18	11/16	1-1/8	25	29.8
1838164K			1	1/4-18	11/16	1-3/16	25	31.8
1838146K	SS		7/8	3/8-18	11/16	1-1/16	25 *	26.8
1838156K	SS	1/2	15/16	3/8-18	11/16	1-1/8	25 *	28.5
1838166K			1	3/8-18	11/16	1-3/16	25	30.5
1838148K	SS		7/8	1/2-14	7/8	1-1/16	20 *	32.1
1838158K	SS	1/2	15/16	1/2-14	7/8	1-1/8	20 *	33.8
1838168K			1	1/2-14	7/8	1-3/16	20	35.8

* 183-SS packaged to order

** NPT thread on 183-SS

184 Series

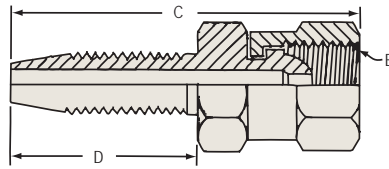

REUSABLE FEMALE SWIVEL STEM

Part Number	Hose ID A	NPSM Thread B	Length C	Stem Length D	Swivel Hex	Std. Pkg.	Lbs. per 100 pcs.
1840404A	1/4	1/4-18	1.94	1.07	11/16	100	7.8
1840406A		3/8-18	2.07	1.07	13/16	50	11.3
1840504A	5/16	1/4-18	2.12	1.17	11/16	50	9.4
1840604A	3/8	1/4-18	2.12	1.17	11/16	50	9.1
1840606A		3/8-18	2.20	1.17	13/16	50	12.5
1840808A	1/2	1/2-14	2.86	1.64	15/16	25	19.0

185 Series

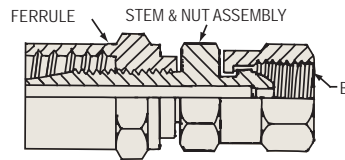

REUSABLE FEMALE SWIVEL FITTING - UNASSEMBLED

Part Number	Hose ID A	Hose OD	NPSM Thread B	Swivel Hex	Ferrule Hex	Std. Pkg.	Lbs. per 100 pcs.
1854084K	1/4	1/2	1/4-18	11/16	11/16	50	13.2
1854094K		9/16	1/4-18	11/16	3/4	50	14.2
1854104K		5/8	1/4-18	11/16	13/16	50	15.1
1854086K	1/4	1/2	3/8-18	13/16	11/16	50	16.6
1854096K		9/16	3/8-18	13/16	3/4	50	17.6
1854106K		5/8	3/8-18	13/16	13/16	50	18.6
1855094K	5/16	9/16	1/4-18	11/16	3/4	50	16.0
1855104K		5/8	1/4-18	11/16	13/16	50	17.3
1855114K		11/16	1/4-18	11/16	7/8	50	18.0
1856104K	3/8	5/8	1/4-18	11/16	13/16	50	16.3
1856114K		11/16	1/4-18	11/16	7/8	50	17.4
1856124K		3/4	1/4-18	11/16	7/8	50	15.8
1856106K	3/8	5/8	3/8-18	13/16	13/16	50	19.7
1856116K		11/16	3/8-18	13/16	7/8	50	20.8
1856126K		3/4	3/8-18	13/16	7/8	50	19.3
1858148K	1/2	7/8	1/2-14	15/16	1-1/16	20	34.8
1858158K		15/16	1/2-14	15/16	1-1/8	20	36.5
1858168K		1	1/2-14	15/16	1-3/16	20	38.5

187 Series

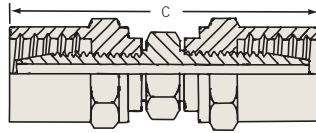

**REUSABLE HOSE
SPLICER - UNASSEMBLED**

Part Number	Hose ID	Hose OD	Length C	Splicer Hex	Ferrule Hex	Std. Pkg.	Lbs. per 100 pcs.
1870408K	1/4	1/2	2.28	9/16	11/16	50	16.2
1870409K		9/16	2.28	9/16	3/4	50	18.2
1870410K		5/8	2.28	9/16	13/16	50	20.1
1870610K	3/8	5/8	2.45	5/8	13/16	25	23.1
1870611K		11/16	2.45	5/8	7/8	25	25.5
1870612K		3/4	2.45	5/8	7/8	25	22.3

268B Series

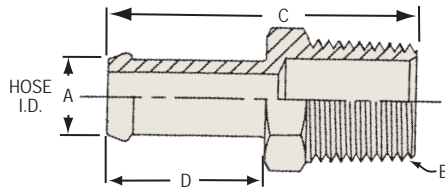

BEADED HOSE BARBS

Part Number	Hose ID A	NPTF Thread B	Length C	Hex	Barb Length D	Std. Pkg.	Lbs. per 100 pcs.
268B0402	1/4	1/8-27	1.18	1/2	.63	100	2.4
268B0404		1/4-18	1.41	9/16	.63	100	3.6
268B0502	5/16	1/8-27	1.18	1/2	.63	100	2.5
268B0504		1/4-18	1.41	9/16	.63	50	3.9
268B0602	3/8	1/8-27	1.43	1/2	.88	100	3.7
268B0604		1/4-18	1.67	9/16	.88	100	4.4
268B0606		3/8-18	1.67	11/16	.88	50	5.8
268B0806	1/2	3/8-18	1.67	11/16	.88	50	6.1
268B0808		1/2-14	1.88	7/8	.88	50	10.9
268B1008	5/8	1/2-14	1.88	7/8	.88	25	11.9
268B1208	3/4	1/2-14	1.88	7/8	.88	50	13.7
268B1212		3/4-14	1.88	1-11/16	.88	25	15.4

Lok-on Hose Fittings

Assembly Instructions

1. Trim hose end with a smooth square cut.
2. Lubricate either Lok-On fitting, hose or both.
3. Insert Lok-On fitting into hose until first barb is in the hose.
4. Place end of fitting against a flat object (bench, wall, etc.) and grip the hose one inch from the end. Push with a steady force until the end of the hose is covered by the yellow plastic cap.

Suggested Compatible Push-Lock Hoses

- Eaton Aeroquip: 2556, 2565, 2575, FC647, FS332
- Eaton Weatherhead: H100, H101, H102, H201
- Gates: LOL, Python
- Goodyear: Autogrip, Insta-Grip, Ultra-Grip
- Parker Hannifin: 801, 804, 821, 831, 836

- CAUTION: Lok-On fittings will properly grip Lok-On hose only when pushed all the way in, with the cut end of the hose completely concealed by the plastic cap. 

270AT Hose Fitting Installation Tool

Features:

- Cuts push-on style hose and inserts the fitting
- Built-in cutter slices through 1/4" - 3/4" I.D. reinforced push-on hose without fraying
- Clamp hose into tool's vice and apply light pressure on handle to drive in the fitting
- Tool has four 7/16" diameter mounting holes for bench mounting
- Overall size is 13-1/2" long x 2-3/8" wide x 7" height



271 Series

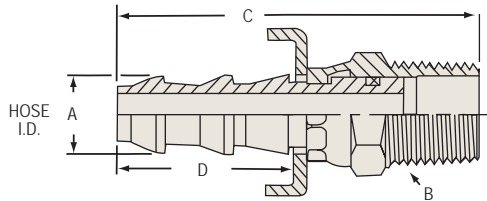

NPTF-MALE SWIVEL HOSE BARB

National Pipe Tapered - Dryseal

Part Number	Hose ID A	NPTF Thread B	Length C	Hex	No. of Barbs	Barb Length D	Std. Pkg.	Lbs. per 100 pcs.
2710402C	1/4	1/8-27	2.09	9/16	2	.81	100	6.8
2710404C		1/4-18	2.02	9/16	2	.87	100	6.1
2710604C	3/8	1/4-18	2.12	9/16	2	.97	50	7.4
2710606C		3/8-18	2.12	11/16	2	.97	50	9.1
2710806C	1/2	3/8-18	2.12	11/16	2	.97	25	10.4
2710808C		1/2-14	2.33	7/8	2	.97	20	14.8
2711212C	3/4	3/4-14	2.80	1-1/16	3	1.45	10	24.8

Note: Swivel for assembly convenience only.

NPTF-MALE HOSE BARB

National Pipe Tapered - Dryseal

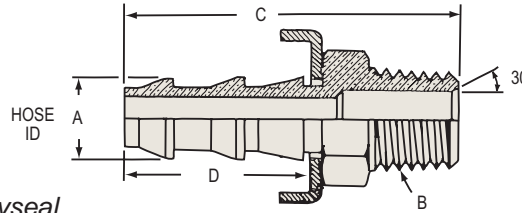

Part Number	303 SS	Hose ID A	NPTF ** Thread B	Length C	Hex	Number of Barbs	Barb Length D	Std. Pkg.	Lbs. per 100 pcs.
2720402C	SS	1/4	1/8-27	1.42	7/16	2	.77	100 *	2.7
2720404C	SS		1/4-18	1.61	9/16	2	.77	100 *	4.3
2720406C	SS		3/8-18	1.61	11/16	2	.77	50	5.6
2720502C		5/16	1/8-27	1.42	7/16	2	.77	100	3.1
2720504C			1/4-18	1.61	9/16	2	.77	50	4.5
2720602C	SS	3/8	1/8-27	1.60	9/16	2	.92	50	5.0
2720604C			1/4-18	1.76	9/16	2	.92	50 *	5.3
2720606C			3/8-18	1.76	11/16	2	.92	50 *	6.7
2720608C			1/2-14	1.97	7/8	2	.92	25	11.0
2720612C			3/4-14	1.97	1-1/16	2	.92	25	15.6
2720804C	SS NEW	1/2	1/4-18	1.86	11/16	2	1.02	25	8.6
2720806C	SS		3/8-18	1.86	11/16	2	1.02	50 *	7.1
2720808C	SS		1/2-14	2.07	7/8	2	1.02	25 *	11.9
2720812C			3/4-14	2.07	1-1/16	2	1.02	25	16.3
2721006C		5/8	3/8-18	2.34	3/4	3	1.50	25	12.0
2721008C			1/2-14	2.55	7/8	3	1.50	25	14.3
2721012C			3/4-14	2.55	1-1/16	3	1.50	25	19.0
2721208C	SS	3/4	1/2-14	2.55	7/8	3	1.50	25 *	20.0
2721212C	SS		3/4-14	2.55	1-1/16	3	1.50	20 *	19.4
2721612C	SS	1	3/4-14	2.93	1-1/4	3	1.50	10	43.7
2721616C			1 - 11-1/2 +	3.11	1-3/8	3	1.50	5 *	49.4

• Add a 'BC' suffix to the part number for the brass cap option. Not available for 5/16" I.D. hose size.

* 272-SS are packaged to order

** NPT thread on 272-SS

+ capped

272W Series



Yellow Lok-on Cap

Part Number	Hose ID	Std. Pkg.
2720400W	1/4	100
2720500W	5/16	100
2720600W	3/8	100
2720800W	1/2	100
2721006W	5/8	50
2721200W	3/4	50
2721600W	1	25

273 Series

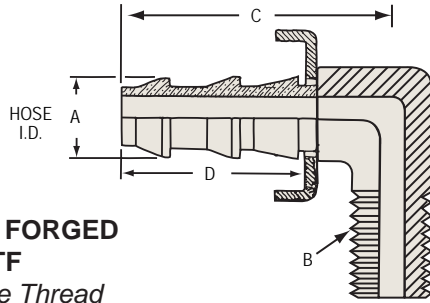

PTF - 90° ELBOW MALE - FORGED
HOSE BARB TO MALE PTF
 PTF - SAE Short Taper Pipe Thread

Part Number	Hose ID A	PTF Thread B	Length Centerline C	No. of Barbs	Barb Length D	Std. Pkg.	Lbs. per 100 pcs.
2730402C	1/4	1/8-27	1.22	2	.82	100	3.7
2730404C		1/4-18	1.40	2	.82	50	6.4
2730602C	3/8	1/8-27	1.35	2	.92	50	4.3
2730604C		1/4-18	1.40	2	.92	50	7.8
2730606C		3/8-18	1.51	2	.92	25	9.5
2730806C	1/2	3/8-18	1.54	2	1.02	25	13.2
2730808C		1/2-14	1.61	2	1.02	25	17.1
2731208C	3/4	1/2-14	2.15	3	1.50	10	25.3
2731212C		3/4-14	2.23	3	1.50	10	28.1

274 Series

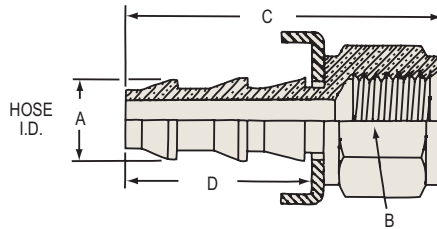

NPTF-FEMALE
HOSE BARB
 National Pipe Tapered - Dryseal

Part Number	Hose ID A	NPTF Thread B	Length C	Hex	No. of Barbs	Barb Length D	Std. Pkg.	Lbs. per 100 pcs.
2740402C	1/4	1/8-27	1.32	1/2	2	.77	100	2.8
2740404C		1/4-18	1.51	5/8	2	.77	100	4.7
2740406C		3/8-18	1.51	3/4	2	.77	50	5.6
2740502C	5/16	1/8-27	1.32	1/2	2	.77	100	3.4
2740504C		1/4-18	1.51	5/8	2	.77	50	4.9
2740602C	3/8	1/8-27	1.47	9/16	2	.92	50	5.6
2740604C		1/4-18	1.66	5/8	2	.92	50	5.5
2740606C		3/8-18	1.66	3/4	2	.92	50	6.5
2740608C		1/2-14	1.66	15/16	2	.92	50	12.0
2740612C		3/4-14	1.97	1-3/16	2	.92	25	20.0
2740804C		1/4-18	1.76	11/16	2	1.02	50	7.8
2740806C	1/2	3/8-18	1.76	3/4	2	1.02	50	7.4
2740808C		1/2-14	1.76	15/16	2	1.02	25	10.0
2740812C		3/4-14	2.07	1-3/16	2	1.02	25	20.2
2741006C	5/8	3/8-18	2.24	3/4	3	1.48	25	10.0
2741008C		1/2-14	2.24	15/16	3	1.48	25	11.0
2741208C	3/4	1/2-14	2.24	15/16	3	1.50	25	13.7
2741212C		3/4-14	2.55	1-3/16	3	1.50	20	23.5
2741612C	1	3/4-14	2.55	1-3/16	3	1.50	10	25.5
2741616C		1 - 11-1/2	2.68	1-7/16	3	1.50	10	37.5

• Add a 'BC' suffix to the part number for the brass cap option. Not available for 5/16" I.D. hose size.

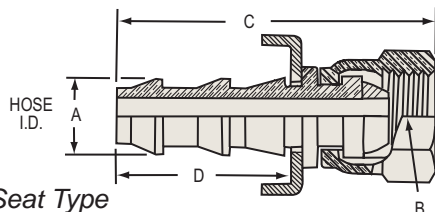
**NPSM - FEMALE
SWIVEL HOSE BARB***National Pipe Straight - Ball Seat Type*

Part Number	Hose ID A	NPSM Thread B	Length C	Hex	No. of Barbs	Barb Length D	Std. Pkg.	Lbs. per 100 pcs.
2780402C		1/8-27	1.39	1/2	2	.77	100	3.1
2780404C	1/4	1/4-18	1.47	11/16	2	.77	50	5.9
2780406C		3/8-18	1.40	11/16	2	.77	50	8.5
2780604C		1/4-18	1.61	11/16	2	.92	50	7.3
2780606C	3/8	3/8-18	1.75	13/16	2	.92	50	9.1
2012 2780608C		1/2-14	1.79	15/16	2	.97	25	10.5
2780808C	1/2	1/2-14	1.88	15/16	2	1.02	50	11.7
2780812C		3/4-14	2.36	1-3/16	2	1.02	25	18.0
2781212C	3/4	3/4-14	2.36	1-3/16	3	1.50	20	21.3

- Add a 'BC' suffix to the part number for the brass cap option.

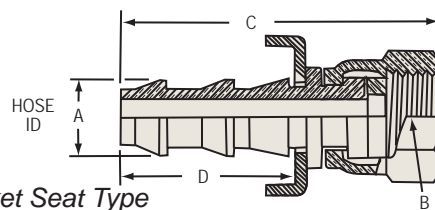
**NPSM - FEMALE
SWIVEL HOSE BARB***National Pipe Straight - Gasket Seat Type*

Part Number	Hose ID A	NPSM Thread B	Length C	Hex	No. of Barbs	Barb Length D	Std. Pkg.	Lbs. per 100 pcs.
2800402C		1/8-27	1.39	1/2	2	.77	100	2.9
2800404C	1/4	1/4-18	1.47	11/16	2	.77	100	5.4
2800604C		1/4-18	1.61	11/16	2	.92	50	7.0
2800606C	3/8	3/8-18	1.75	13/16	2	.92	50	8.6
2800608C		1/2-14	1.80	15/16	2	.92	50	9.4
2800808C	1/2	1/2-14	1.88	15/16	2	1.02	25	10.8
2801008C	5/8	1/2-14	2.36	15/16	3	1.50	25	17.8
2801212C	3/4	3/4-14	2.36	1-3/16	3	1.50	20	18.3

- Add a 'BC' suffix to the part number for the brass cap option.

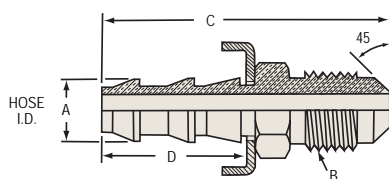
**MALE HOSE BARB
45° SAE**

Part Number	Hose ID A	Tube OD	UNF Thread B	Length C	Hex	Number of Barbs	Barb Length D	Std. Pkg.	Lbs. per 100 pcs.
2820407C		1/4	7/16-20	1.50	7/16	2	.77	100	3.0
2820408C		5/16	1/2-20	1.59	1/2	2	.77	100	4.0
2820610C	3/8	3/8	5/8-18 *	1.83	5/8	2	.92	50	7.4
2820812C	1/2	1/2	3/4-16	2.12	3/4	2	1.02	50	11.5
2821014C	5/8	5/8	7/8-14	2.73	7/8	3	1.50	25	19.4
2821217C	3/4	3/4	1 - 1/16-14 *	2.98	1-1/16	3	1.50	25	32.0

* Notch in hex for SAE identification

- Add a 'BC' suffix to the part number for the brass cap option.

284 Series

FEMALE SWIVEL HOSE BARB
45° SAE

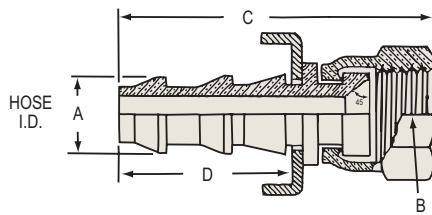

Part Number	Hose ID A	Tube OD	UNF Thread B	Length C	Hex	Number of Barbs	Barb Length D	Std. Pkg.	Lbs. per 100 pcs.
2840410C	1/4	3/8	5/8-18 *	1.60	3/4	2	.77	50	6.6
2840510C	5/16	3/8	5/8-18 *	1.60	3/4	2	.77	50	6.7
2840610C	3/8	3/8	5/8-18 *	1.75	3/4	2	.92	50	7.1
2841217C	3/4	3/4	1 - 1/16-14 *	2.54	1-1/4	3	1.50	10	26.7

* Notch in nut for SAE identification

• Add a 'BC' suffix to the part number for the brass cap option. Not available for 5/16" I.D. hose size.

286 Series

MALE HOSE BARB
37° JIC

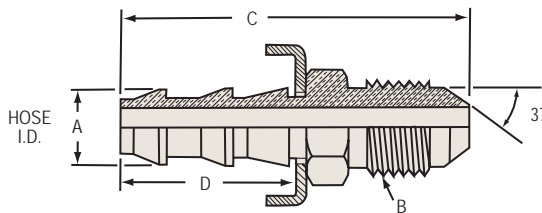

Part Number	Hose ID A	Tube OD	UNF Thread B	Length C	Hex	Number of Barbs	Barb Length D	Std. Pkg.	Lbs. per 100 pcs.
2860407C		1/4	7/16-20	1.59	1/2	2	.77	100	3.4
2860408C	1/4	5/16	1/2-20	1.59	5/8	2	.77	50	4.6
2860409C		3/8	9/16-18	1.63	5/8	2	.77	100	5.1
2860609C	3/8	3/8	9/16-18	1.78	5/8	2	.92	50	5.9
2860812C	1/2	1/2	3/4-16	1.98	7/8	2	1.02	25	11.8
2861014C	5/8	5/8	7/8-14	2.62	15/16	3	1.50	25	18.5
2861217C	3/4	3/4	1 - 1/16-12 *	2.79	1-1/8	3	1.50	10	29.0

* UN Thread

• Add a 'BC' suffix to the part number for the brass cap option.

287 Series

FEMALE SWIVEL HOSE BARB
45° SAE / 37° JIC (dual angle seat)

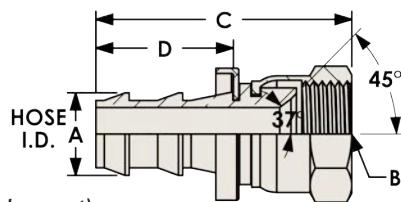

Part Number	303 SS	Hose ID A	Tube OD	UNF Thread B	Length C	Hex	No. of Barbs	Barb Length D	Std. Pkg.	Lbs. per 100 pcs.
2870407C	SS		1/4	7/16-20	1.50	9/16	2	.77	100 *	3.8
2870408C		1/4	5/16	1/2-20	1.60	5/8	2	.77	100	5.1
2870608C			5/16	1/2-20	1.75	5/8	2	.92	25	7.1
2870612C		3/8	1/2	3/4-16	1.82	7/8	2	.92	25	9.0
2870812C	SS	1/2	1/2	3/4-16	1.93	7/8	2	1.02	25 *	10.7
2870814C			5/8	7/8-14	1.99	1	2	1.02	25	12.8
2871014C		5/8	5/8	7/8-14	2.47	1	3	1.50	25	17.4

• Add a 'BC' suffix to the part number for the brass cap option.

* 287-SS are packaged to order

FEMALE SWIVEL HOSE BARB
37°

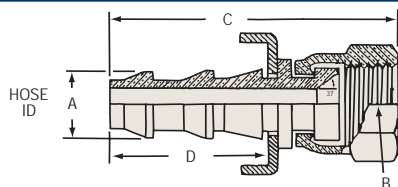

288 Series

Part Number	303 SS	Hose ID A	Tube OD	UNF Thread B	Length C	Hex	No. of Barbs	Barb Length D	Std. Pkg.	Lbs. per 100 pcs.
2880409C		1/4	3/8	9/16-18	1.60	11/16	2	.77	50	5.3
2880509C		5/16	3/8	9/16-18	1.60	11/16	2	.82	50	5.8
2880609C	SS	3/8	3/8	9/16-18	1.75	11/16	2	.92	50 *	6.5
2880809C		1/2	3/8	9/16-18	1.85	11/16	2	1.02	25	9.4
2881217C	SS	3/4	3/4	1 - 1/16-12 **	2.53	1-1/4	3	1.50	10 *	25.9
2881621C	SS	1	1	1 - 5/16-12 **	2.67	1-7/16	3	1.50	10 *	32.5

• Add a 'BC' suffix to the part number for the brass cap option. Not available for 5/16" I.D. hose size.

* 288-SS are packaged to order

** UN Thread

FEMALE SWIVEL 90° ELBOW
37° JIC / 45° SAE - PLATED STEEL

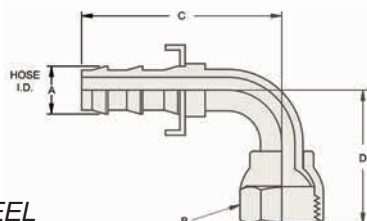

289 Series

Part Number	Hose ID A	Tube OD	UNF Thread B	Length Centerline C	Length Centerline D	No. of Barbs	Std. Pkg.	Lbs. per 100 pcs.
2890407C +	1/4	1/4	7/16-20	1.55	.83	2	25	5.6
2890407CSAE *		1/4	7/16-20	1.60	.83	2	25	6.4
2890609C +	3/8	3/8	9/16-18	1.85	.91	2	25	10.0
2890610CSAE *		3/8	5/8-18	1.98	.85	2	25	11.2
2890812C +	1/2	1/2	3/4-16	2.33	1.09	2	10	18.1
2890812CSAE *		1/2	3/4-16	2.33	1.09	2	10	18.1
2891217C +	3/4	3/4	1 - 1/16-12 **	3.26	1.81	3	5	40.0

* Notch in nut for SAE identification

** UN Thread

+ JIC only, may substitute dual angle

SAE INVERTED FLARE MALE SWIVEL HOSE BARB

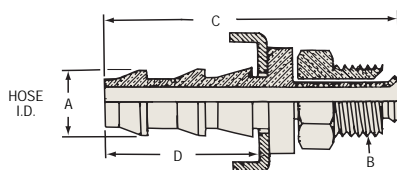

290 Series

Part Number	Hose ID A	Tube OD	UNF Thread B	Length C	Hex	Number of Barbs	Barb Length D	Std. Pkg.	Lbs. per 100 pcs.
2900406C	1/4	3/16	3/8-24	1.52	7/16	2	.77	100	3.2
2900407C		1/4	7/16-24 *	1.52	7/16	2	.77	100	3.1
2900408C		5/16	1/2-20	1.58	1/2	2	.77	100	3.8
2900508C	5/16	5/16	1/2-20	1.58	1/2	2	.77	50	4.1
2900510C		3/8	5/8-18	1.63	5/8	2	.77	50	6.1
2900608C	3/8	5/16	1/2-20	1.73	1/2	2	.92	100	5.8
2900610C		3/8	5/8-18	1.78	5/8	2	.92	50	7.0
2900812C		1/2	3/4-18 *	1.96	3/4	2	1.02	50	10.5
2901014C	5/8	5/8	7/8-18 *	2.50	7/8	3	1.50	25	14.9

* UNS Thread

• Add a 'BC' suffix to the part number for the brass cap option. Not available for 5/16" ID hose size.

292 Series

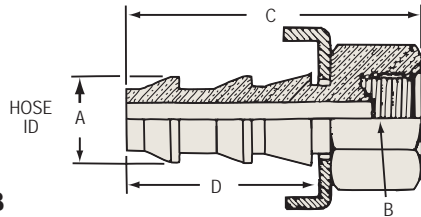

SAE INVERTED FLARE RIGID FEMALE HOSE BARB

Part Number	Hose ID A	Tube OD B	UNF Thread B	Length C	Hex D	Number of Barbs	Barb Length D	Std. Pkg.	Lbs. per 100 pcs.
2920406C		3/16	3/8-24	1.17	7/16	2	.77	100	2.3
2920407C	1/4	1/4	7/16-24 *	1.16	1/2	2	.77	100	2.1
2920408C		5/16	1/2-20	1.19	9/16	2	.77	100	2.7
2920508C	5/16	5/16	1/2-20	1.19	9/16	2	.77	100	3.9
2920608C		5/16	1/2-20	1.34	9/16	2	.92	100	4.4
2920610C	3/8	3/8	5/8-18	1.39	3/4	2	.92	50	5.4
2920812C	1/2	1/2	3/4-18 *	1.54	7/8	2	1.02	25	7.8

* UNS Thread

• Add a 'BC' suffix to the part number for the brass cap option.

294 Series

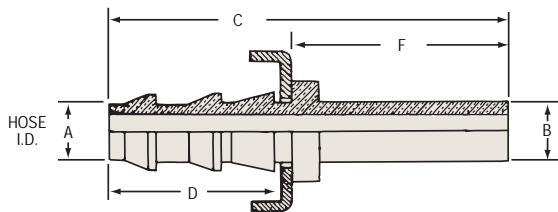

RIGID TUBE SHANK HOSE BARB

Part Number	Hose ID A	Tube OD B	Length C	Tube Length F	No. of Barbs	Barb Length D	Std. Pkg.	Lbs. per 100 pcs.
2940403C		3/16	1.68	.86	2	.77	100	1.9
2940404C	1/4	1/4	1.88	1.06	2	.77	100	1.8
2940405C		5/16	1.88	1.06	2	.77	100	2.6
2940606C	3/8	3/8	2.03	1.06	2	.92	50	3.5
2940808C	1/2	1/2	2.13	1.06	2	1.02	50	5.9
2941010C	5/8	5/8	2.61	1.06	3	1.50	25	9.7
2941212C	3/4	3/4	2.61	1.06	3	1.50	25	25.3

• Add a 'BC' suffix to the part number for the brass cap option.

296 Series

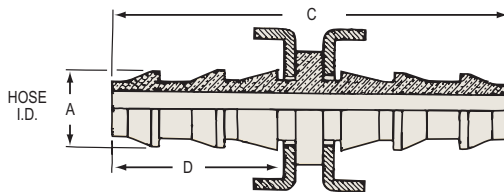

HOSE SPLICER

Part Number	303 SS	Hose ID A	Length C	No. of Barbs	Barb Length D	Barb Std. Pkg.	Lbs. per 100 pcs.
2960404C	SS	1/4	1.73	2	.77	100 *	2.5
2960505C		5/16	1.73	2	.77	100	3.4
2960606C	SS	3/8	2.05	2	.92	50 *	7.5
2960808C	SS	1/2	2.25	2	1.02	50 *	7.5
2961010C		5/8	3.21	3	1.50	25	12.4
2961212C		3/4	3.21	3	1.50	20	15.4
2961616C		1	3.21	3	1.50	10	28.7

• Add a 'BC' suffix to the part number for the brass cap option. Not available for 5/16" I.D. hose size.

* 296-SS are packaged to order

Brass Pipe Fittings

163 Series

HEX HEAD PLUG NPT- Part is hollow

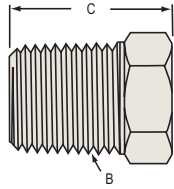

Part Number	NPT Thread B	Overall Length C	Hex	Std. Pkg.	Lbs. per 100 pcs.
1630200C	1/8-27	.56	7/16	50	1.7
1630400C	1/4-18	.63	9/16	100	3.4
1630600C	3/8-18	.78	11/16	25	5.1
1630800C	1/2-14	.97	7/8	25	8.0
1631200C	3/4-14	1.06	1-1/16	25	14.1
1631600C	1 - 11-1/2	1.35	1-3/8	10	28.0

165 Series

CLOSE PIPE NIPPLE NPT

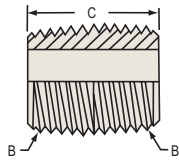

Part Number	NPT Thread B	Length C	Flow Diameter	Std. Pkg.	Lbs. per 100 pcs.
1650202C	1/8-27	.75	.250	50	1.0
1650404C	1/4-18	.88	.375	50	2.0
1650606C	3/8-18	1.00	.500	100	3.4
1650808C	1/2-14	1.12	.625	25	5.5
1651212C	3/4-14	1.31	.750	25	11.3
1651616C	1 - 11-1/2	1.75	.935	25	15.6

166 Series

LONG PIPE NIPPLE NPT

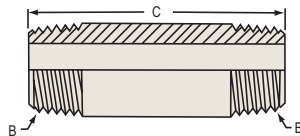

Part Number	NPT Thread B	Length C	Flow Diameter	Std. Pkg.	Lbs. per 100 pcs.
1660215C	1/8-27	1.50	.256	25	2.6
1660220C		2.00	.250	25	3.8
1660225C		2.50	.250	25	4.9
1660230C		3.00	.256	25	6.8
1660235C		3.50	.256	10	6.9
1660240C		4.00	.256	10	7.7
1660415C	1/4-18	1.50	.375	25	4.4
1660420C		2.00	.375	25	5.9
1660425C		2.50	.375	25	8.4
1660430C		3.00	.375	25	10.1
1660435C		3.50	.375	10	11.9
1660440C		4.00	.375	10	13.7
1660450C		5.00	.375	5	17.6
1660615C	3/8-18	1.50	.500	25	6.4
1660620C		2.00	.500	25	8.7
1660625C		2.50	.500	10	11.7
1660630C		3.00	.500	10	14.0
1660635C		3.50	.500	10	16.6
1660640C		4.00	.500	5	19.2

• The last two digits of the part number represent the overall length.

166 Series

LONG PIPE NIPPLE NPT (continued)

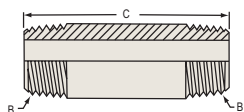

Part Number	NPT Thread B	Length C	Flow Diameter	Std. Pkg.	Lbs. per 100 pcs.
1660815C	1/2-14	1.50	.625	10	9.4
1660820C		2.00	.625	10	12.7
1660825C		2.50	.625	10	16.3
1660830C		3.00	.625	10	20.2
1660835C		3.50	.625	10	23.8
1660840C		4.00	.625	5	27.6
1661220C	3/4-14	2.00	.840	5	17.9
1661225C		2.50	.840	5	23.1
1661230C		3.00	.840	5	28.0
1661235C		3.50	.840	5	32.9

- The last two digits of the part number represent the overall length.

169 Series

90° MALE PIPE ELBOW- Forged PTF - Dryseal

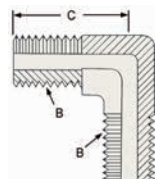

Part Number	PTF Thread B	Length Centerline C	Std. Pkg.	Lbs. per 100 pcs.
1690202C	1/8-27	.70	25	3.7
1690404C	1/4-18	.83	25	6.6
1690606C	3/8-18	.94	25	8.7
1690808C	1/2-14	1.10	25	16.5

172 Series

MALE UNION NPSM to NPTF

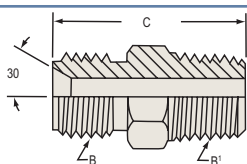

Part Number	NPSM Thread B	NPTF Thread B'	Length C	Hex	Std. Pkg.	Lbs. per 100 pcs.
1720202C	1/8	1/8-27	.94	7/16	100	2.5
1720402C	1/4	1/8-27	1.06	9/16	100	3.9
1720404C		1/4-18	1.25	9/16	100	5.1
1720604C	3/8	1/4-18	1.28	11/16	100	6.5
1720606C		3/8-18	1.30	11/16	50	8.1
1720608C		1/2-14	1.47	7/8	50	13.0
1720806C	1/2	3/8-18	1.35	7/8	50	10.5
1720808C		1/2-14	1.53	7/8	50	13.1
1721212C	3/4	3/4-14	1.53	1-1/16	25	18.8

174 Series

ADAPTER NPSM to NPTF

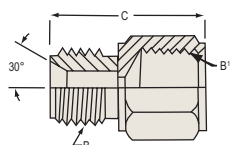

Part Number	NPSM Thread B	NPTF Thread B'	Length C	Hex	Std. Pkg.	Lbs. per 100 pcs.
1740404C	1/4	1/4	1.12	5/8	100	5.6
1740606C	3/8	3/8	1.15	3/4	50	6.9
1740808C	1/2	1/2	1.22	15/16	50	10.6

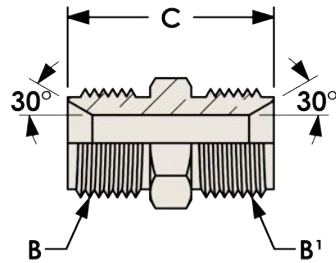

MALE UNION
NPSM to NPSM

Part Number	NPSM Thread B	NPSM Thread B¹	Length C	Hex	Std. Pkg.	Lbs. per 100 pcs.
1760202C	1/8	1/8	.79	7/16	100	2.0
1760404C	1/4	1/4	1.09	9/16	100	4.2
1760606C	3/8	3/8	1.19	11/16	100	7.2
1760808C	1/2	1/2	1.31	7/8	50	10.4

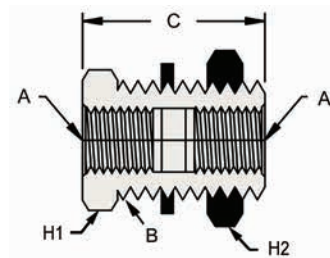

BULKHEAD ANCHOR COUPLING

Part Number	NPTF Pipe Thread A	UNS Straight Thread B¹	Hex H1	Hex H2	Length C	Std. Pkg.	Lbs. per 100 pcs.
207BH2	1/8-27	5/8-18	7/8	15/16	1.50	25	16.3
207BH4	1/4-18	3/4-16	1	1	1.50	25	19.4
207BH4S		3/4-16	1	1	.94	25	15.0
207BH6	3/8-18	1-14	1-1/8	1-1/4	1.31	10	27.5
207BH8	1/2-14	1-1/8-14	1-1/4	1-3/8	1.50	10	33.1
207BH12	3/4-14	1-5/16-12	1-1/2	1-1/2	1.50	10	41.3

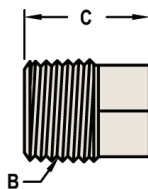

SQUARE HEAD PLUG
NPT

Part Number	NPT Thread B	Length C	Square	Std. Pkg.	Lbs. per 100 pcs.
2110200C	1/8-27	.59	9/32	50	2.0
2110400C	1/4-18	.80	3/8	100	3.0
2110600C	3/8-18	.83	7/16	25	6.0
2110800C	1/2-14	1.07	9/16	25	13.0
2111200C	3/4-14	1.14	5/8	25	20.0

213 Series

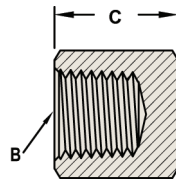

PIPE CAP
NPT

Part Number	NPT Thread B	Length C	Hex	Std. Pkg.	Lbs. per 100 pcs.
2130200C	1/8-27	.50	9/16	50	3.0
2130400C	1/4-18	.63	5/8	100	4.0
2130600C	3/8-18	.63	13/16	25	6.0
2130800C	1/2-14	.87	1	25	8.0
2131200C	3/4-14	.89	1-3/16	25	16.0

219 Series



HEX SOCKET PLUG
NPT

Part Number	NPT Thread B	Length C	Hex	Std. Pkg.	Lbs. per 100 pcs.
2190200C	1/8-27	.30	3/16	50	1.0
2190400C	1/4-18	.46	1/4	100	2.0
2190600C	3/8-18	.46	5/16	25	3.0
2190800C	1/2-14	.61	3/8	25	5.0
2191200C	3/4-14	.62	9/16	25	10.0

228 Series

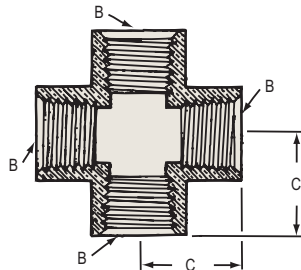

FEMALE PIPE CROSS- Extruded
NPTF - Dryseal

Part Number	NPTF Thread B	C	Std. Pkg.	Lbs. per 100 pcs.
2280202C	1/8-27	.57	25	9.6
2280404C	1/4-18	.78	25	19.5
2280606C	3/8-18	.84	25	26.7
2280808C	1/2-14	1.07	10	54.2
2281212C	3/4-14	1.16	10	72.1

302 Series

90° FEMALE PIPE ELBOW- Extruded
 NPTF - Dryseal
 Ref. SAE 130238

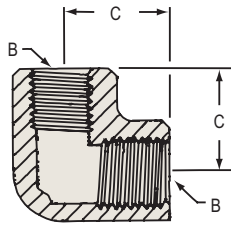

Part Number	NPTF Thread B	C	Std. Pkg.	Lbs. per 100 pcs.
3020202C	1/8-27	.55	25	6.3
3020404C	1/4-18	.78	25	14.8
3020606C	3/8-18	.84	25	20.0
3020808C	1/2-14	1.09	25	38.6
3021212C	3/4-14	1.16	10	58.1

304 Series

FULL PATTERN 90° STREET ELBOW- Extruded
 NPTF - Dryseal
 Ref. SAE 130239

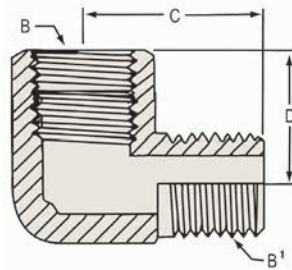

Part Number	NPTF Thread B	NPTF Thread B'	C	D	Std. Pkg.	Lbs. per 100 pcs.
3040202C	1/8-27	1/8-27	.66	.48	25	4.9
3040402C	1/4-18	1/8-27	.72	.45	25	11.3
3040404C		1/4-18	.91	.72	25	12.0
3040604C	3/8-18	1/4-18	1.25	.78	25	14.4
3040606C		3/8-18	.97	.78	25	16.4
3040806C	1/2-14	3/8-18	1.25	.97	25	32.3
3040808C		1/2-14	1.24	1.09	25	37.3
3041208C	3/4-14	1/2-14	1.39	1.10	25	50.3
3041212C		3/4-14	1.38	1.12	10	51.9

306 Series

45° STREET ELBOW- Extruded
 NPTF - Dryseal
 Ref. SAE 130339

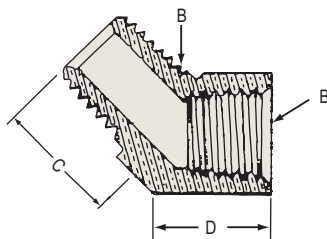

Part Number	NPTF Thread B	C	D	Std. Pkg.	Lbs. per 100 pcs.
3060202C	1/8-27	.50	.38	25	3.7
3060404C	1/4-18	.72	.56	25	7.6
3060606C	3/8-18	.72	.56	25	11.9
3060808C	1/2-14	1.00	.75	25	25.8
3061212C	3/4-14	1.06	.75	10	34.1

322 Series

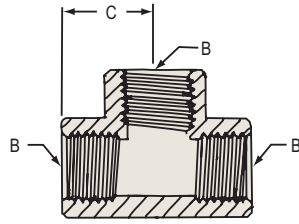

FEMALE PIPE TEE- Extruded

NPTF - Dryseal
Ref. SAE 130438

Part Number	NPTF Thread B	C	Std. Pkg.	Lbs. per 100 pcs.
3220202C	1/8-27	.55	25	7.7
3220404C	1/4-18	.78	25	19.1
3220606C	3/8-18	.84	25	23.2
3220808C	1/2-14	1.09	25	47.1
3221212C	3/4-14	1.16	10	65.3

324 Series

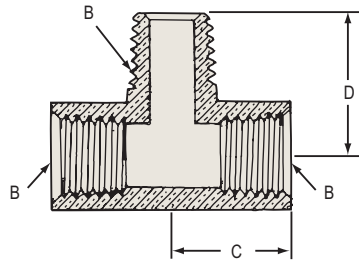

MALE BRANCH TEE- Extruded

NPTF - Dryseal
Ref. SAE 130425

Part Number	NPTF Thread B	C	D	Std. Pkg.	Lbs. per 100 pcs.
3240202C	1/8-27	.55	.66	25	6.4
3240404C	1/4-18	.78	.91	25	16.1
3240606C	3/8-18	.84	.97	25	22.3
3240808C	1/2-14	1.09	1.25	25	42.4
3241212C	3/4-14	1.09	1.25	10	58.0

326 Series

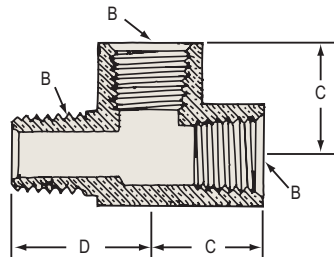

STREET TEE- Extruded

NPTF - Dryseal
Ref. SAE 130424

Part Number	NPTF Thread B	C	D	Std. Pkg.	Lbs. per 100 pcs.
3260202C	1/8-27	.55	.73	25	6.3
3260404C	1/4-18	.78	.91	25	15.8
3260606C	3/8-18	.84	.97	25	21.6
3260808C	1/2-14	1.09	1.28	25	44.3
3261212C	3/4-14	1.09	1.38	10	59.1

370 Series

MALE HEX NIPPLE
NPTF - Dryseal
Ref. SAE 130137

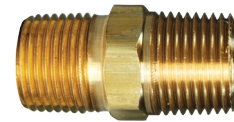
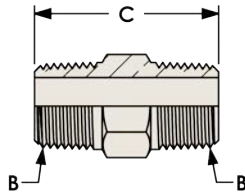

Part Number	NPTF Thread B	Length C	Hex	Std. Pkg.	Lbs. per 100 pcs.
3700202C	1/8-27	.97	7/16	100	2.5
3700404C	1/4-18	1.38	9/16	100	5.4
3700606C	3/8-18	1.41	11/16	50	7.7
3700808C	1/2-14	1.81	7/8	25	14.4
3701212C	3/4-14	1.75	1-1/16	25	21.4
3701616C	1 - 11-1/2	2.24	1-3/8	10	40.0

371 Series

FEMALE HEX COUPLING
NPTF - Dryseal
Ref. SAE 130138

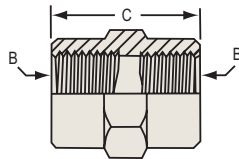

Part Number	NPTF Thread B	Length C	Hex	Std. Pkg.	Lbs. per 100 pcs.
3710202C	1/8-27	.75	9/16	25	3.3
3710404C	1/4-18	1.12	3/4	25	8.8
3710606C	3/8-18	1.12	7/8	25	10.4
3710808C	1/2-14	1.50	1-1/16	25	19.9
3711212C	3/4-14	1.57	1-3/8	10	37.2

373 Series

REDUCER BUSHING
NPTF - Dryseal
Ref. SAE 130140

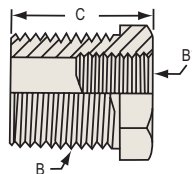

Part Number	NPTF Thread B External	NPTF Thread B¹ Internal	Length C	Hex	Std. Pkg.	Lbs. per 100 pcs.
3730402C	1/4-18	1/8-27	.75	9/16	100	2.6
3730602C	3/8-18	1/8-27	.75	11/16	100	5.3
3730604C		1/4-18	.75	3/4	100	4.0
3730802C	1/2-14	1/8-27	1.00	7/8	25	12.9
3730804C		1/4-18	1.00	7/8	50	10.4
3730806C		3/8-18	1.00	7/8	50	7.3
3731202C *	3/4-14	1/8-27	.94	1-1/16	25	21.6
3731204C		1/4-18	1.00	1-1/8	25	20.5
3731206C		3/8-18	1.00	1-1/8	25	22.1
3731208C		1/2-14	1.00	1-1/8	25	12.5
3731604C *	1-11-1/2	1/4-18	1.12	1-3/8	10	48.7
3731606C *		3/8-18	1.12	1-7/16	10	43.7
3731608C		1/2-14	1.12	1-7/16	10	37.2
3731612C		3/4-14	1.12	1-7/16	10	27.0

* SAE does not provide a standard for these sizes.

375 Series

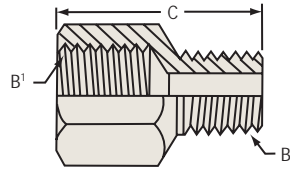

ADAPTER
NPTF - Dryseal
Ref. SAE 130139

Part Number	NPTF Thread B' Internal	NPTF Thread B External	Length C	Hex	Std. Pkg.	Lbs. per 100 pcs.
3750202C	1/8-27	1/8-27	.88	9/16	100	3.6
3750402C	1/4-18	1/8-27	1.06	3/4	50	7.3
3750404C		1/4-18	1.25	3/4	50	8.8
3750602C	3/8-18	1/8-27	1.07	7/8	50	7.4
3750604C		1/4-18	1.25	7/8	50	10.2
3750606C		3/8-18	1.25	7/8	50	10.6
3750804C	1/2-14	1/4-18	1.47	1-1/16	25	9.8
3750806C		3/8-18	1.47	1-1/16	25	18.3
3750808C		1/2-14	1.66	1-1/16	25	20.6
3751206C	3/4-14	3/8-18	1.50	1-3/8	10	18.0
3751208C		1/2-14	1.69	1-3/8	10	33.2
3751212C		3/4-14	1.69	1-3/8	10	34.3

377 Series

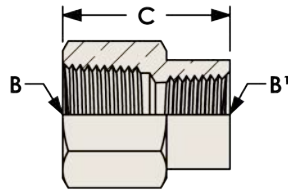

REDUCER COUPLER
NPTF - Dryseal (double female)
Ref. SAE 130138

Part Number	NPTF Thread B'	NPTF Thread B	Length C	Hex	Std. Pkg.	Lbs. per 100 pcs.
3770402C	1/4-18	1/8-27	.97	3/4	50	7.5
3770602C	3/8-18	1/8-27	1.00	7/8	50	5.7
3770604C		1/4-18	1.16	7/8	50	11.6
3770804C	1/2-14	1/4-18	1.28	1-1/16	25	13.3
3770806C		3/8-18	1.38	1-1/16	10	20.1
3771206C	3/4-14	3/8-18	1.38	1-3/8	10	18.4
3771208C		1/2-14	1.50	1-3/8	10	23.1

379 Series

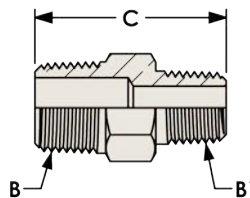

MALE REDUCING HEX NIPPLE
NPTF - Dryseal
Ref. SAE 130137

Part Number	NPTF Thread B	NPTF Thread B'	Length C	Hex	Std. Pkg.	Lbs. per 100 pcs.
3790402C	1/4-18	1/8-27	1.19	9/16	100	4.5
3790602C	3/8-18	1/8-27	1.22	11/16	50	6.3
3790604C		1/4-18	1.41	11/16	50	7.4
3790804C	1/2-14	1/4-18	1.62	7/8	50	10.5
3790806C		3/8-18	1.62	7/8	50	12.3
3791208C	3/4-14	1/2-14	1.80	1-1/16	25	18.9

Garden Hose Fittings and Accessories

500 Series

Features:

- 125 max PSI
- Working Temperature 33°F - 180°F
- EPDM gasket
- Stainless steel components

ACCESSORIES - BAR STOCK

Part Number	Description
500BFP	back flow preventer



NOZZLES

Part Number	Description
500AN4	4" adjustable nozzle
500AN7	6" adjustable nozzle
500SN2	2" sweeper nozzle, machined brass
500SN6	6" sweeper nozzle, machined brass

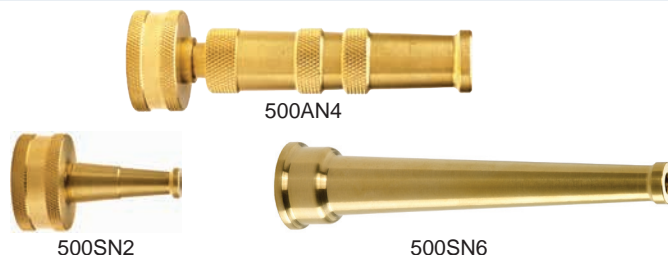

ACCESSORIES- Forged

Part Number	Description
500GHV	Forged brass ball valve, 3/4 NH male x female
500GHY	Double Y valve, swivel inlet - with Higbie cut threads (capped) to prevent cross threading
500YC	Y coupler, nickel plated brass
500GH4VBK	GH 4 valve manifold, swivel inlet, black knob



COUPLERS

Part Number	303 SS	Description
500QCF	SS	Female coupler
500QCSG		Garden hose coupler seal gasket
500QCFV		Valved coupler, water shutoff
500QCM	SS	Male plug, extended thread
500QCK	SS	Complete assembly
500QCKV		Complete assembly, valved



COMPONENTS

Part Number	Description
5911212F	Filter Washer, 1.00" OD, 304 stainless steel mesh, black 70 duro PVC
5911212W	Washer, .63" ID, 1.00" OD black 80 duro SBR
5911616W	Washer, .86" ID, 1.27" OD black 60 duro SBR
5861012N	3/4" Garden hose nut round with knurl
5911212N *	3/4" Garden hose nut hex with knurl
5911616N *	1" Garden hose nut (NPSH) hex with knurl

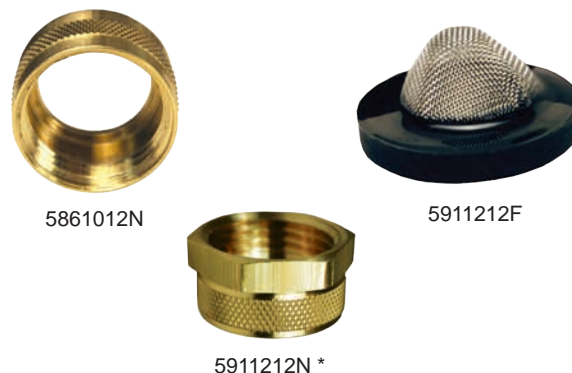

* Dixon Brass is in the process of upgrading the nut to a diamond knurl. This change will provide an improved gripping surface.

Note: Hose fittings stem components are also available separately. Contact the factory for availability and pricing.

501 Series

FEMALE HOSE x FEMALE PIPE

Non-swivel NH x NPTF



303 Stainless Steel

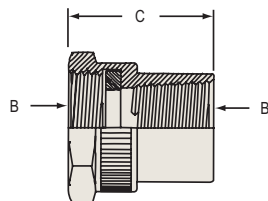

CDA Brass 360 *

Part Number	303 SS	NH Thread B	NPTF Thread B ¹	Length C	Hex	Std. Pkg.	Lbs. per 100 pcs.
5011202C			1/8-27	1.02	1-3/16	50	9.9
5011204C			1/4-18	1.12	1-3/16	25	10.4
5011206C		3/4 - 11-1/2	3/8-18	1.18	1-3/16	25	10.6
5011208C	SS		1/2-14 *	1.32	1-3/16	25 *	12.4
5011212C	SS		3/4-14 *	1.56	1-3/16	25 *	13.0

* 501-SS threads B¹ are NPT and the parts are packaged to order

* Dixon Brass is in the process of upgrading the nut to a diamond knurl. This change will provide an improved gripping surface.

502 Series

FEMALE HOSE x FEMALE PIPE

Swivel NH x NPTF



303 Stainless Steel

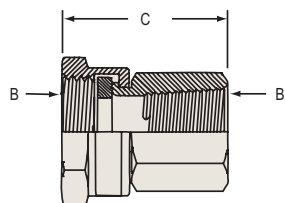

CDA Brass 360

Part Number	303 SS	NH Thread B	NPTF Thread B ¹	Length C	Hex	Std. Pkg.	Lbs. per 100 pcs.
5021208C	SS	3/4 - 11-1/2	1/2-14 *	1.33	1	25	15.4
5021212C	SS		3/4-14 *	1.59	1-3/16	10	22.3

* 502-SS threads B¹ are NPT and the parts are packaged to order

503 Series

FEMALE HOSE x MALE PIPE

Non-swivel NH x NPTF



303 Stainless Steel

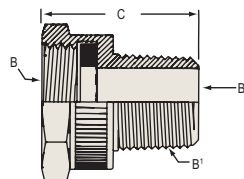

CDA Brass 360 *

Part Number	303 SS	NH Thread B	NPTF Thread B ¹	NPTF Thread B ²	Length C	Hex	Std. Pkg.	Lbs. per 100 pcs.
5031206C			3/8-18	---	1.37	1-3/16	25	11.3
5031208C	SS	3/4 - 11-1/2	1/2-14 *	---	1.37	1-3/16	25 *	13.0
5031212C	SS		3/4-14 *	1/2-14	1.37	1-3/16	25 *	14.0

* 503-SS threads B¹ are NPT and the parts are packaged to order

* Dixon Brass is in the process of upgrading the nut to a diamond knurl. This change will provide an improved gripping surface.

504 Series

FEMALE HOSE x MALE PIPE

Swivel - Internal and External Hex NH x NPTF



303 Stainless Steel

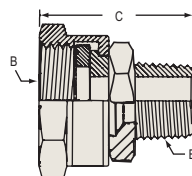

CDA Brass 360

Part Number	303 SS	NH Thread B	NPTF Thread B ¹	Length C	Hex	Std. Pkg.	Lbs. per 100 pcs.
5041204C			1/4-18	1.43	1-3/16	25	12.5
5041206C		3/4 - 11-1/2	3/8-18	1.43	1-3/16	25	15.1
5041208C	SS		1/2-14 *	1.63	1-3/16	25 *	16.3
5041212C	SS		3/4-14 *	1.43	1-3/16	25 *	19.4

* 504-SS threads B¹ are NPT and the parts are packaged to order

506 Series

FEMALE HOSE x FEMALE HOSE

Swivel NH x NH

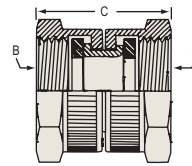

Part Number	NH Thread B	Length C	Hex	Std. Pkg.	Lbs. per 100 pcs.
5061212C	3/4 - 11-1/2	1.32	1-3/16	25	14.1

* Dixon Brass is in the process of upgrading the nut to a diamond knurl. This change will provide an improved gripping surface.

507 Series

MALE HOSE x FEMALE PIPE

NH x NPTF



303 Stainless Steel

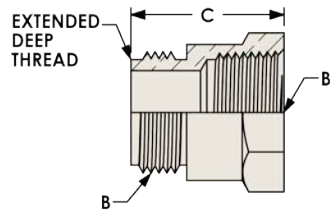

CDA Brass 360

Part Number	303 SS	NH Thread B	NPTF Thread B'	Length C	Hex	Std. Pkg.	Lbs. per 100 pcs.
5071204C		3/4 - 11-1/2	1/4-18	.75	1-1/16	25	13.6
5071206C			3/8-18	.75	1-1/16	25	11.1
5071208C	SS	3/4 - 11-1/2	1/2-14 *	.75	1-1/16	25 *	7.9
5071212C	SS		3/4-14 *	1.37	1-3/16	25 *	20.0

* 507-SS threads B' are NPT and the parts are packaged to order

508 Series

MALE HOSE x MALE PIPE

NH x NPTF



303 Stainless Steel

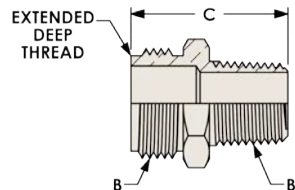

CDA Brass 360

Part Number	303 SS	NH Thread B	NPTF Thread B'	Length C	Hex	Std. Pkg.	Lbs. per 100 pcs.
5081206C		3/4 - 11-1/2	3/8-18	1.31	1-1/16	25	11.9
5081208C			1/2-14 *	1.50	1-1/16	25 *	13.5
5081212C	SS	3/4 - 11-1/2	3/4-14 *	1.50	1-1/16	25 *	16.7
5081216C	SS		1 - 11-1/2	1.85	1-3/8	10	22.5

* 508-SS threads B' are NPT and the parts are packaged to order

509 Series

MALE HOSE x MALE HOSE

NH x NH



303 Stainless Steel

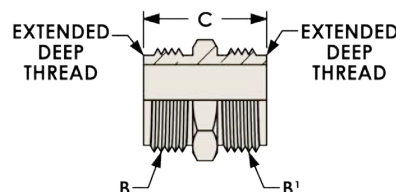

CDA Brass 360

Part Number	303 SS	NH Thread B	NH Thread B'	Length C	Hex	Std. Pkg.	Lbs. per 100 pcs.
5091212C	SS	3/4 - 11-1/2	3/4 - 11-1/2	1.24	1-1/16	25 *	13.1
5091612C		1 - 11-1/2 **	3/4 - 11-1/2	1.43	1-3/8	20	18.9

* 509-SS are packaged to order

** NPSH thread

513 Series

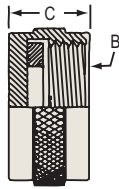

HOSE CAP

Round

Part Number	NH Thread B	Length C	Std. Pkg.	Lbs. per 100 pcs.
5131212C	3/4 - 11-1/2	.625	25	7.8

514 Series

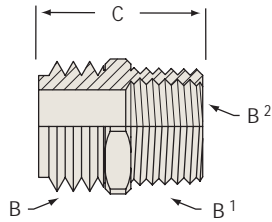

MALE HOSE x MALE PIPE x FEMALE PIPE

NH x NPTF x NPTF

Part Number	NH Thread B	NPTF Thread B ¹	NPTF Thread B ²	Length C	Hex	Std. Pkg.	Lbs. per 100 pcs.
5141212C	3/4 - 11-1/2	3/4-14	1/2-14	1.50	1-1/16	25	16

578 Series

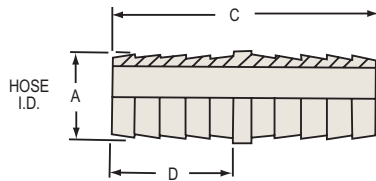

GARDEN HOSE MENDER

Part Number	Hose ID A	Length C	No. of Barbs	Barb Length D	Std. Pkg.	Lbs. per 100 pcs.
5780808C	1/2	2.06	4	.97	50	6.5
5781010C	5/8	2.06	4	.97	50	8.6
5781212C	3/4	2.50	4	1.19	25	12.9
5781616C	1	3.00	5	1.44	10	22.5

585 Series

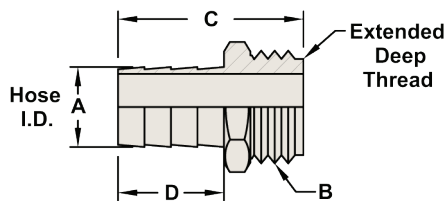

SHORT SHANK MALE GARDEN HOSE FITTING

Part Number	Hose ID A	NH Thread B	Length C	Hex	No. of Barbs	Barb Length D	Std. Pkg.	Lbs. per 100 pcs.
5850812C	1/2	3/4 - 11-1/2	1.75	1-1/16	3	1.00	25	11.0
5851012C	5/8	3/4 - 11-1/2	1.75	1-1/16	3	1.00	25	11.9
5851212C	3/4	3/4 - 11-1/2	1.75	1-1/16	3	1.00	25	13.4

586 Series

SHORT SHANK FEMALE SWIVEL GARDEN HOSE FITTING
(round nut)

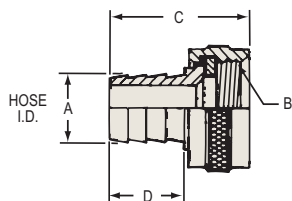

Part Number	Hose ID A	NH Thread B	Length C	No. of Barbs	Barb Length D	Std. Pkg.	Lbs. per 100 pcs.
5860812C	1/2	3/4 - 11-1/2	1.63	3	1.00	25	9.8
5861012C	5/8	3/4 - 11-1/2	1.63	3	1.00	25	10.2
5861212C	3/4	3/4 - 11-1/2	1.63	3	1.00	25	11.5

587 Series

SHORT SHANK GARDEN HOSE FITTING SET *
(round nut)

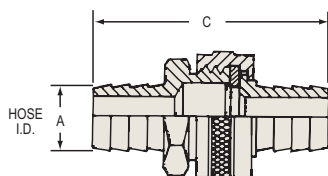

Part Number	Hose ID A	NH Thread B	Length C	No. of Barbs	Std. Pkg.	Lbs. per 100 pcs.
5870808K	1/2	3/4 - 11-1/2	2.95	3	25	20.8
5871010K	5/8	3/4 - 11-1/2	2.95	3	25	22.1
5871212K	3/4	3/4 - 11-1/2	2.95	3	25	25.0

* not assembled

588 Series

SHORT SHANK FEMALE SWIVEL GARDEN HOSE FITTING
(hex nut)

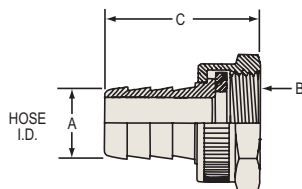

Part Number	Hose ID A	NH Thread B	Length C	No. of Barbs	Barb Length D	Std. Pkg.	Lbs. per 100 pcs.
5880812C	1/2	3/4 - 11-1/2	1.63	3	1.00	25	10.7
5881012C	5/8	3/4 - 11-1/2	1.63	3	1.00	25	10.9
5881212C	3/4	3/4 - 11-1/2	1.63	3	1.00	25	12.1

* Dixon Brass is in the process of upgrading the nut to a diamond knurl. This change will provide an improved gripping surface.

589 Series

SHORT SHANK GARDEN HOSE FITTING SET *
(hex nut)

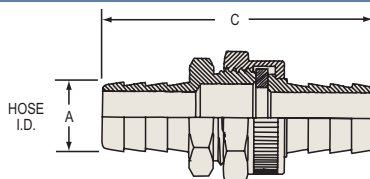

Part Number	Hose ID A (both fittings)	NH Thread B	Length C	No. of Barbs	Std. Pkg.	Lbs. per 100 pcs.
5890808K	1/2	3/4 - 11-1/2	2.95	3	25	21.7
5891010K	5/8	3/4 - 11-1/2	2.95	3	25	22.9
5891212K	3/4	3/4 - 11-1/2	2.95	3	25	25.6

* not assembled

** Dixon Brass is in the process of upgrading the nut to a diamond knurl. This change will provide an improved gripping surface.

590 Series



303 Stainless Steel

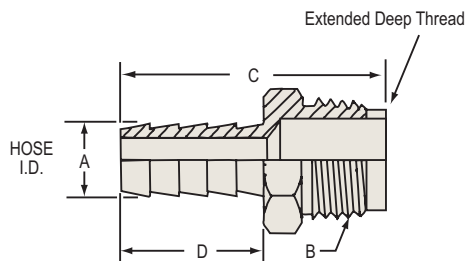

CDA Brass 360

MALE GARDEN HOSE FITTING

Part Number	303 SS	Hose ID A	NH Thread B	Length C	Hex	No. of Barbs	Barb Length D	Std. Pkg.	Lbs. per 100 pcs.
5900612C		3/8	3/4 - 11-1/2	1.94	1-1/16	4	1.19	25	11.3
5900812C	SS	1/2	3/4 - 11-1/2	1.94	1-1/16	4	1.19	25 *	12.3
5901012C	SS	5/8	3/4 - 11-1/2	1.94	1-1/16	4	1.19	25 *	14.5
5901212C	SS	3/4	3/4 - 11-1/2	1.94	1-1/16	4	1.19	25 *	15.1
5901612C		1	3/4 - 11-1/2	1.94	1-1/16	4	1.19	10	21.4
5901616C		1	1 - 11-1/2 **	2.38	1-3/8	5	1.44	10	25.6

* 590-SS are packaged to order

** NPSH thread - extended

591 Series



303 Stainless Steel

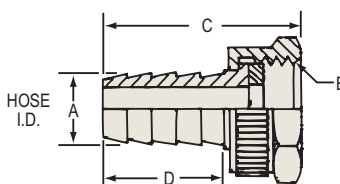

CDA Brass 360

FEMALE SWIVEL GARDEN HOSE FITTING

Part Number	303 SS	Hose ID A	NH Thread B ¹	Length C	Hex	No. of Barbs	Barb Length D	Std. Pkg.	Lbs. per 100 pcs.
5910612C		3/8	3/4 - 11-1/2	1.82	1-3/16	4	1.19	25	11.2
5910812C	SS	1/2	3/4 - 11-1/2	1.82	1-3/16	4	1.19	25 *	11.5
5911012C	SS	5/8	3/4 - 11-1/2	1.82	1-3/16	4	1.19	25 *	12.2
5911212C	SS	3/4	3/4 - 11-1/2	1.82	1-3/16	4	1.19	25 *	13.5
5911612C		1	3/4 - 11-1/2	2.10	1-3/16	4	1.19	10	25.2
5911616C		1	1 - 11-1/2 **	2.25	1-7/16	5	1.44	10	24.4

* 591-SS are packaged to order

** NPSH thread

*** Dixon Brass is in the process of upgrading the nut to a diamond knurl. This change will provide an improved gripping surface.

592 Series



303 Stainless Steel

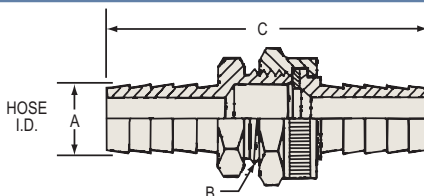

CDA Brass 360

GARDEN HOSE FITTING SET - not assembled

Part Number	303 SS	Hose ID (both fittings) A	NH Thread B ¹	Length C	No. of Barbs	Barb Length D	Std. Pkg.	Lbs. per 100 pcs.
5920606K		3/8	3/4 - 11-1/2	3.32	4	1.19	25	22.5
5920808K	SS	1/2	3/4 - 11-1/2	3.32	4	1.19	25 *	23.8
5921010K	SS	5/8	3/4 - 11-1/2	3.32	4	1.19	25 *	26.7
5921212K	SS	3/4	3/4 - 11-1/2	3.32	4	1.19	25 *	28.6
5921612K		1	3/4 - 11-1/2	3.60	4	1.19	10	46.7
5921616K		1	1 - 11-1/2 **	4.19	5	1.44	10	50.0

* 592-SS are packaged to order

** NPSH thread

*** Dixon Brass is in the process of upgrading the nut to a diamond knurl. This change will provide an improved gripping surface.

593 Series

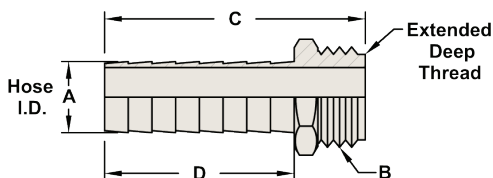

LONG SHANK MALE GARDEN HOSE FITTING

Part Number	Hose ID A	NH Thread B	Length C	Hex	No. of Barbs	Barb Length D	Std. Pkg.	Lbs. per 100 pcs.
5930812C	1/2	3/4 - 11-1/2	2.78	1-1/16	7	2.03	25	13.8
5931012C	5/8	3/4 - 11-1/2	2.78	1-1/16	7	2.03	25	15.1
5931212C	3/4	3/4 - 11-1/2	2.78	1-1/16	7	2.03	10	17.9
5931616C	1	1 - 11-1/2 *	2.96	1- 3/8	7	2.03	5	28.9

* NPSH thread

594 Series

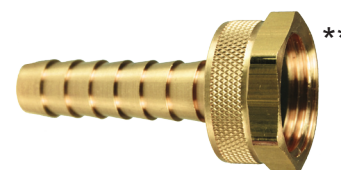
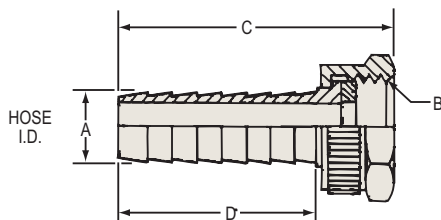

LONG SHANK FEMALE SWIVEL GARDEN HOSE FITTING

Part Number	Hose ID A	NH Thread B	Length C	Hex	No. of Barbs	Barb Length D	Std. Pkg.	Lbs. per 100 pcs.
5940812C	1/2	3/4 - 11-1/2	2.66	1-3/16	7	2.03	25	13.0
5941012C	5/8	3/4 - 11-1/2	2.66	1-3/16	7	2.03	25	14.2
5941212C	3/4	3/4 - 11-1/2	2.66	1-3/16	7	2.03	10	16.7
5941616C	1	1 - 11-1/2 *	2.84	1-7/16	7	2.03	5	28.8

* NPSH thread

** Dixon Brass is in the process of upgrading the nut to a diamond knurl. This change will provide an improved gripping surface.

595 Series

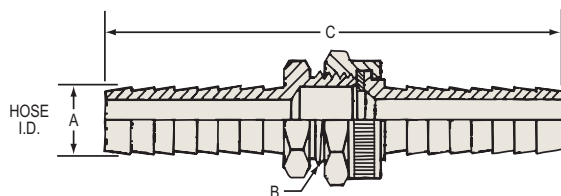

LONG SHANK GARDEN HOSE FITTING SET **

Part Number	Hose ID A (both fittings)	NH Thread B	Length C	No. of Barbs	Std. Pkg.	Lbs. per 100 pcs.
5950808K	1/2	3/4 - 11-1/2	5.05	7	25	26.9
5951010K	5/8	3/4 - 11-1/2	5.05	7	25	29.3
5951212K	3/4	3/4 - 11-1/2	5.05	7	10	34.6
5951616K	1	1 - 11-1/2 *	5.20	7	5	57.6

* NPSH thread

** Not assembled

*** Dixon Brass is in the process of upgrading the nut to a diamond knurl. This change will provide an improved gripping surface.

Grease Whip Hose Assemblies and Couplings

GWH Series



Features:

- One piece brass crimp couplings
- 1/8-27 male NPT thread, solid base
- US manufactured to 3/16" ID hose - meets SAE100R1-AT; working pressure of **3000 PSI**
- For use with hand grease guns only
- Available with optional retail packaging or strain relief spring

HOSE ASSEMBLIES

Part Number	Assembly Length	Strain Relief Spring	Retail Pack	Std. Pkg.
GWH0800	8"	Add 'S' suffix to part number		Per customer requirement
GWH1200	12"	Add 'S' suffix to part number	Add 'R' suffix to part number	
GWH1800	18"	Add 'S' suffix to part number	Add 'R' suffix to part number	
GWH2400	24"	Add 'S' suffix to part number		
GWH3600	36"	Add 'S' suffix to part number		
GWH4800	48"	Add 'S' suffix to part number		
GWH6000	60"	Add 'S' suffix to part number		

For lengths not listed, call for quote (50 minimum)



COUPLER and FITTINGS

Part Number	Description	Material	Retail Pack	Std. Pkg.
GWHC	Grease hose coupler with ball check	Zinc Plated Steel	Add 'R' suffix to part number	10
GWHC-FF	Grease hose coupler - Full Flow	Zinc Plated Steel	Add 'R' suffix to part number	10
0010055C	1/8-27 male NPT thread, drilled and chamfered base	Brass		100
0010260C	1/8-27 male NPT thread, solid base	Brass		100
0010860C	1/8-27 female NPT thread	Brass		100

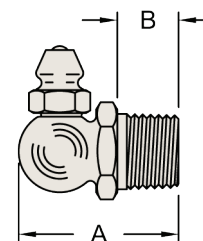
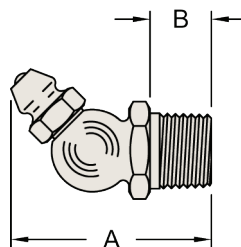
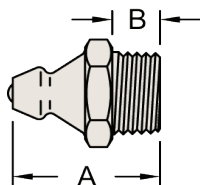

2012
GWHZ000
GWHZ400

GWHZ045
GWHZ445

GWHZ090
GWHZ490

GHWZ- ZERK FITTINGS

Zinc Plated Steel

Part Number	Description	Thread	A Overall Length	B Thread Length	Hex	Std. Pkg	Lbs. per 100 pcs.
GWHZ000	Ball check	1/8-27 NPT	.66	.26	.43	100	1.00
GWHZ045	45° Angle ball check	1/8-27 NPT	.86	.28	.43	100	1.00
GWHZ090	90° Angle ball check	1/8-27 NPT	.83	.31	.43	100	1.00
GWHZ400	Ball check	1/4-28 Tapered SAE-LT	.53	.20	.312	100	1.00
GWHZ445	45° Angle ball check	1/4-28 Tapered SAE-LT	.80	.20	.375	100	1.00
GWHZ490	90° Angle ball check	1/4-28 Tapered SAE-LT	1.20	.20	.375	100	1.00

All items available in retail packs of 10 - Add R to part number: Order 1 for 1 Retail Pack of 10 pcs.

Compression Fittings

60 Series

SLEEVE 60C

Reference SAE 060115

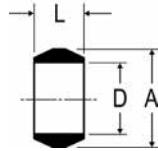

Part Number	Tube Size	A	D	L	Std. Pkg.
60C-02	1/8	.187	.130	.19	100
60C-03	3/16	.266	.192	.22	100
60C-04	1/4	.344	.255	.25	100
60C-05	5/16	.406	.318	.25	100
60C-06	3/8	.469	.382	.25	100
60C-07	7/16	.531	.444	.31	100
60C-08	1/2	.594	.507	.38	100
60C-10	5/8	.719	.632	.38	100
60C-12	3/4	.875	.758	.44	50
60C-14	7/8	1.000	.883	.41	50

DELRIN® SLEEVE 60PT

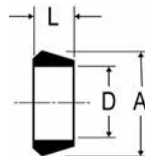

Part Number	Plastic Tube Wall	Tube Wall	A	D	L	Std. Pkg.
60PT-04	1/4	.40	.375	.254	.19	200
60PT-05	5/16	.62	.438	.317	.19	100
60PT-06	3/8	.62	.500	.379	.19	100
60PT-08	1/2	.62	.631	.507	.25	100
60PT-10	5/8	.62	.747	.632	.22	100

NUT 61C

Reference SAE 060110

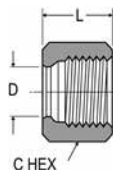

Part Number	Tube Size	Straight Thread	Hex C	D	L	Std. Pkg.
61C-02	1/8	5/16-24	3/8	.130	.38	100
61C-03	3/16	3/8-24	7/16	.192	.41	100
61C-04	1/4	7/16-24	1/2	.255	.44	100
61C-05	5/16	1/2-24	9/16	.318	.44	50
61C-06	3/8	9/16-24	5/8	.382	.47	100
61C-07	7/16	5/8-24	11/16	.444	.50	25
61C-08	1/2	11/16-20	13/16	.507	.62	50
61C-10	5/8	13/16-18	15/16	.632	.62	25
61C-12	3/4	1-18	1-3/16	.758	.69	25
61C-14	7/8	1-1/8-18	1-1/4	.890	.62	25

LONG NUT 61CL

Reference SAE 060111

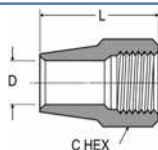

Part Number	Tube Size	Straight Thread	Hex C	D	L	Std. Pkg.
61CL-04	1/4	7/16-24	1/2	.255	.75	10
61CL-05	5/16	1/2-24	9/16	.318	.84	10
61CL-06	3/8	9/16-24	5/8	.382	.97	10
61CL-08	1/2	11/16-20	13/16	.507	1.06	10
61CL-10	5/8	13/16-18	15/16	.632	1.19	10
61CL-12	3/4	1-18	1-3/16	.758	1.38	10

62C Series

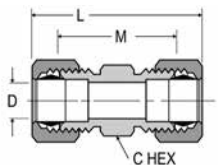

UNION 62C

Reference SAE 060101 BA

Part Number	Tube Size	Straight Thread	Hex C	L	M	Flow Diameter	Std. Pkg.
62C-02	1/8	5/16-24	5/16	1.05	.64	.094	25
62C-03	3/16	3/8-24	3/8	1.21	.72	.125	25
62C-04	1/4	7/16-24	7/16	1.33	.79	.188	50
62C-05	5/16	1/2-24	1/2	1.39	.85	.250	50
62C-06	3/8	9/16-24	9/16	1.52	.97	.312	50
62C-07	7/16	5/8-24	5/8	1.70	1.02	.312	10
62C-08	1/2	11/16-20	11/16	1.90	1.08	.406	25
62C-10	5/8	13/16-18	13/16	2.06	1.23	.500	10
62C-12	3/4	1-18	1	2.37	1.41	.562	10
62C-14	7/8	1-1/8-18	1-1/8	2.07	1.19	.766	10

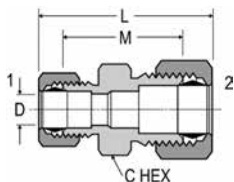

UNION REDUCERS 62C

Reference SAE 060101 BA

Part Number	1 Tube Size	2 Tube Size	1 Str. Thread	2 Str. Thread	Hex C	L	M	Flow Diameter	Std. Pkg.
62C-0403	3/16	1/4	3/8-24	7/16-24	7/16	1.29	.78	.125	10
62C-0604	1/4	3/8	7/16-24	9/16-24	9/16	1.46	.97	.188	10
62C-0806	3/8	1/2	9/16-24	11/16-20	11/16	1.71	1.03	.312	10
62C-1006	3/8	5/8	9/16-24	13/16-18	13/16	1.82	1.13	.312	10

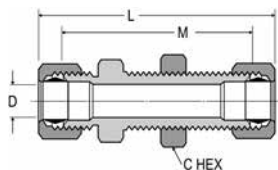

BULKHEAD UNION 62CBH

Part Number	Tube Size	Straight Thread	Hex C	L	M	Flow Diameter	Std. Pkg.
62CBH-04	1/4	7/16-24	9/16	2.29	1.75	.188	10
62CBH-06	3/8	9/16-24	11/16	2.42	1.88	.312	10

63 Series

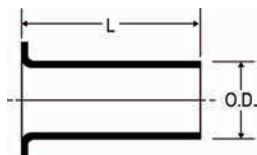

INSERTS 63PT

for industrial grade plastic tubing

Part Number	Tube OD	Tube Wall	L	OD	Std. Pkg.
63PT-0216		.016	.46	.080	100
63PT-0223	1/8	.023	.45	.073	200
63PT-0232		.032	.31	.061	200
63PT-0325		.025	.45	.135	100
63PT-0340	3/16	.040	.52	.095	100
63PT-0440		.040	.50	.163	200
63PT-0462	1/4	.062	.33	.110	50
63PT-0540		.040	.50	.232	100
63PT-0562	5/16	.062	.53	.187	100
63PT-0662	3/8	.062	.56	.250	200
63PT-0862	1/2	.062	.72	.370	100
63PT-1062	5/8	.062	.72	.483	100

Delrin® sleeve 60 PT and Insert 63PT convert standard compression fittings for use with industrial grades of thermoplastic tubing.

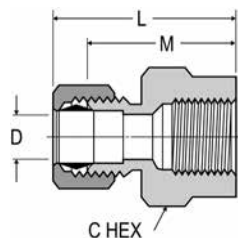

FEMALE CONNECTOR 66C
Reference SAE 060103 BA

Part Number	Tube Size	NPTF Thread	UNF Thread	Hex C	L	M	Flow Diameter	Std. Pkg.
66C-0202	1/8	1/8	5/16-24	9/16	.95	.75	.094	10
66C-0302	3/16	1/8	3/8-24	9/16	1.02	.78	.125	25
66C-0304		1/4	3/8-24	11/16	1.20	.96	.125	10
66C-0402	1/4	1/8	7/16-24	9/16	1.02	.78	.188	25
66C-0404		1/4	7/16-24	11/16	1.24	1.00	.188	10
66C-0502	5/16	1/8	1/2-24	9/16	1.07	.81	.250	10
66C-0504		1/4	1/2-24	11/16	1.29	1.03	.250	10
66C-0602	3/8	1/8	9/16-24	9/16	1.06	.78	.312	10
66C-0604		1/4	9/16-24	11/16	1.34	1.06	.312	10
66C-0606		3/8	9/16-24	13/16	1.34	1.06	.312	10
66C-0608		1/2	9/16-24	1	1.54	1.27	.312	10
66C-0804	1/2	1/4	11/16-20	11/16	1.49	1.09	.406	10
66C-0806		3/8	11/16-20	13/16	1.52	1.12	.406	10
66C-0808		1/2	11/16-20	1	1.71	1.31	.406	10
66C-1008		5/8	1/2	13/16-18	1	1.80	1.38	.500

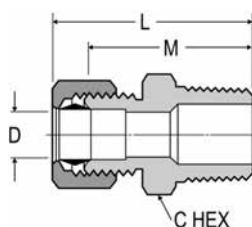

MALE CONNECTOR 68C
Reference SAE 060102 BA

Part Number	Tube Size	Pipe Thread	Straight Thread	Hex C	L	M	Flow Diameter	Std. Pkg.
68C-0202	1/8	1/8	5/16-24	7/16	.97	.77	.094	25
68C-0302	3/16	1/8	3/8-24	7/16	1.08	.84	.125	50
68C-0304		1/4	3/8-24	9/16	1.27	1.03	.125	25
68C-0402	1/4	1/8	7/16-24	7/16	1.10	.86	.188	50
68C-0404		1/4	7/16-24	9/16	1.30	1.06	.188	50
68C-0406		3/8	7/16-24	11/16	1.27	1.03	.188	10
68C-0408		1/2	7/16-24	7/8	1.55	1.31	.188	10
68C-0502	5/16	1/8	1/2-24	1/2	1.15	.89	.234	25
68C-0504		1/4	1/2-24	9/16	1.33	1.07	.250	50
68C-0602	3/8	1/8	9/16-24	9/16	1.25	.97	.250	25
68C-0604		1/4	9/16-24	9/16	1.42	1.14	.312	25
68C-0606		3/8	9/16-24	11/16	1.44	1.16	.312	25
68C-0608		1/2	9/16-24	7/8	1.53	1.25	.312	25
68C-0704	7/16	1/4	5/8-24	5/8	1.50	1.17	.312	10
68C-0804	1/2	1/4	11/16-20	11/16	1.62	1.22	.312	10
68C-0806		3/8	11/16-20	11/16	1.60	1.20	.406	25
68C-0808		1/2	11/16-20	7/8	1.71	1.31	.406	25
68C-1006	5/8	3/8	13/16-18	13/16	1.73	1.31	.406	10
68C-1008		1/2	13/16-18	7/8	1.90	1.48	.500	10
68C-1012		3/4	13/16-18	1-1/16	1.98	1.56	.500	10
68C-1208	3/4	1/2	1-18	1	2.05	1.60	.562	10
68C-1212		3/4	1-18	1-1/16	2.08	1.63	.656	10
68C-1412		7/8	3/4	1-1/8-18	1-1/8	1.76	1.41	.750

164C and 264C Series

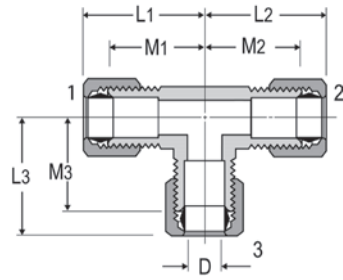

164C

UNION TEE 164C-264C

Reference SAE 060401 BA

Part Number	Tube Size 1 and 2	Tube Size 3	Straight Thread	L1	L2	L3	M1	M2	M3	Flow Diameter	Std. Pkg.
164C-02	1/8	1/8	5/16-24	.82	.82	.82	.61	.61	.61	.094	10
264C-03	3/16	3/16	3/8-24	.84	.84	.84	.60	.60	.60	.125	10
164C-04	1/4	1/4	7/16-24	.86	.86	.86	.61	.61	.61	.188	25
164C-05	5/16	5/16	1/2-24	.98	.98	.98	.71	.71	.71	.250	10
164C-06	3/8	3/8	9/16-24	1.03	1.03	1.03	.74	.74	.74	.312	25
164C-08	1/2	1/2	11/16-20	1.34	1.34	1.34	.93	.93	.93	.406	10
164C-10	5/8	5/8	13/16-18	1.54	1.54	1.54	1.08	1.08	1.08	.500	10
164C-6-6-4	3/8	1/4	---	1.03	1.03	.96	.75	.75	.72	.188	25
164C-8-8-6	1/2	3/8	---	1.34	1.34	1.16	.94	.94	.88	.312	10

165C Series

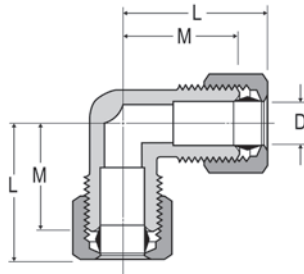

UNION ELBOW 165C

Reference SAE 060201 BA

Part Number	Tube Size	Straight Thread	L	M	Flow Diameter	Std. Pkg.
165C-02	1/8	5/16-24	.82	.61	.094	10
165C-03	3/16	3/8-24	.87	.61	.125	10
165C-04	1/4	7/16-24	.88	.61	.188	10
165C-05	5/16	1/2-24	.95	.71	.250	10
165C-06	3/8	9/16-24	1.03	.74	.312	10
165C-07	7/16	5/8-24	1.16	.82	.312	5
165C-08	1/2	11/16-20	1.34	.93	.406	10
165C-10	5/8	13/16-18	1.48	1.05	.500	10
165C-12	3/4	1-18	1.65	1.17	.560	5

169C and 269C Series

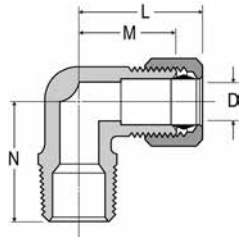

MALE ELBOW 169C-269C
Reference SAE 060202 BA

Part Number	Tube Size	Pipe Thread	Straight Thread	L	M	N	Flow Diameter D	Std. Pkg.
269C-0202	1/8	1/8	5/16-24	.80	.60	.67	.094	10
169C-0302	3/16	1/8	3/8-24	.84	.61	.69	.125	10
169C-0304		1/4	3/8-24	.86	.64	.93	.125	10
169C-0402	1/4	1/8	7/16-24	.86	.61	.74	.188	50
169C-0404		1/4	7/16-24	.86	.62	.94	.188	50
169C-0406		3/8	7/16-24	.93	.68	1.00	.188	10
169C-0502	5/16	1/8	1/2-24	.88	.61	.74	.234	10
169C-0504		1/4	1/2-24	.95	.71	.93	.250	25
169C-0506		3/8	1/2-24	1.01	.75	1.00	.250	10
169C-0602	3/8	1/8	9/16-24	1.03	.74	.74	.234	10
169C-0604		1/4	9/16-24	1.03	.74	.93	.312	25
169C-0606		3/8	9/16-24	1.03	.75	1.00	.312	25
169C-0608		1/2	9/16-24	1.22	.94	1.27	.312	10
169C-0804	1/2	1/4	11/16-20	1.34	.94	1.00	.312	10
169C-0806		3/8	11/16-20	1.34	.93	1.11	.406	10
169C-0808		1/2	11/16-20	1.48	1.06	1.15	.406	10
169C-1008	5/8	1/2	13/16-18	1.48	1.06	1.31	.500	10
169C-1208	3/4	1/2	1-18	1.64	1.18	1.49	.562	5
169C-1212		3/4	1-18	1.70	1.27	1.58	.562	5

170C Series

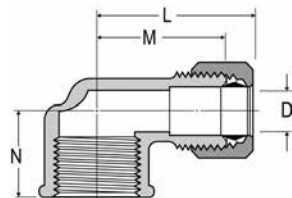

FEMALE ELBOW 170C
Reference SAE 060203 BA

Part Number	Tube Size	Pipe Thread	Straight Thread	L	M	N	Flow Diameter D	Std. Pkg.
170C-0202	1/8	1/8	5/16-24	.89	.69	.56	.094	10
170C-0302	3/16	1/8	3/8-24	.98	.73	.56	.125	25
170C-0402	1/4	1/8	7/16-24	.93	.69	.56	.188	25
170C-0404		1/4	7/16-24	1.02	.78	.70	.188	25
170C-0604	3/8	1/4	9/16-24	1.06	.79	.73	.312	10
170C-0606		3/8	9/16-24	1.22	.94	.69	.312	10
170C-0704	7/16	1/4	5/8-24	1.27	.93	.73	.312	5
170C-0806	1/2	3/8	11/16-20	1.34	1.00	.69	.406	10

171C Series

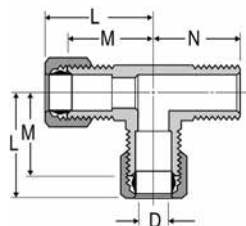

MALE RUN TEE 171C

Part Number	Tube Size	Pipe Thread	Straight Thread	L	M	N	Flow Diameter D	Std. Pkg.
171C-0202	1/8	1/8	5/16-24	.82	.61	.71	.094	10
171C-0302	3/16	1/8	3/8-24	.86	.61	.71	.125	10
171C-0402	1/4	1/8	7/16-24	.90	.64	.75	.188	10
171C-0404		1/4	7/16-24	.93	.69	.72	.188	10
171C-0604	3/8	1/4	9/16-24	1.09	.81	1.03	.312	10

172C Series

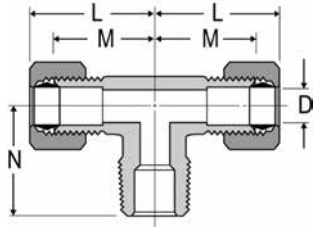

MALE BRANCH TEE 172C
Reference SAE 060425 BA

Part Number	Tube Size	Pipe Thread	Straight Thread	L	M	N	Flow Diameter D	Std. Pkg.
172C-0202	1/8	1/8	5/16-24	.82	.61	.71	.094	10
172C-0302	3/16	1/8	3/8-24	.86	.61	.71	.125	10
172C-0402	1/4	1/8	7/16-24	.86	.61	.74	.188	10
172C-0404		1/4	7/16-24	.93	.69	.92	.188	10
172C-0602	3/8	1/8	9/16-24	1.03	.75	.75	.234	10
172C-0604		1/4	9/16-24	1.09	.77	1.03	.312	10
172C-0606		3/8	9/16-24	1.09	.81	1.00	.312	10
172C-0806	1/2	3/8	11/16-20	1.34	.93	1.10	.406	10

176C Series

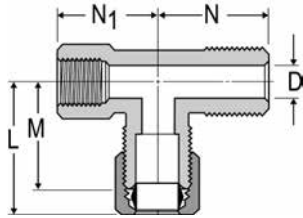

ADAPTER TEE 176C

Part Number	Tube Size	Pipe Thread	Straight Thread	L	M	N	N'	Flow Diameter D	Std. Pkg.
176C-0402	1/4	1/8	7/16-24	.93	.69	.75	.66	.189	10

177C Series

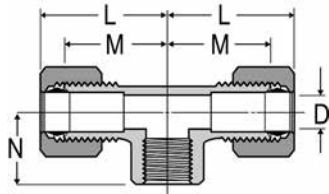

FEMALE BRANCH TEE 177C

Part Number	Tube Size	Pipe Thread	Straight Thread	L	M	N	Flow Diameter D	Std. Pkg.
177C-0402	1/4	1/8	7/16-24	.86	.63	.53	.188	10

179C Series

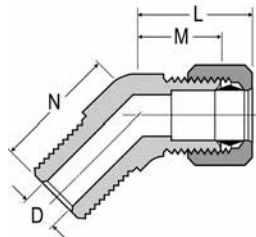

45° ELBOW 179C

Part Number	Tube Size	Pipe Thread	Straight Thread	L	M	N	Flow Diameter D	Std. Pkg.
179C-0402	1/4	1/8	7/16-24	.90	.66	.56	.188	10
179C-0404		1/4	7/16-24	.80	.56	.84	.188	10
179C-0602	3/8	1/8	9/16-24	.90	.63	.65	.234	10
179C-0604		1/4	9/16-24	.90	.63	.84	.312	10
179C-0606		3/8	9/16-24	.97	.75	.95	.312	10
179C-0806	1/2	3/8	11/16-20	1.15	.81	.95	.406	10

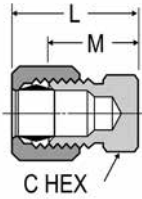

SEAL PLUG 639C

Part Number	Tube Size	Straight Thread	Hex C	L	M	Std. Pkg.
639C-04	1/4	7/16-24	7/16	.74	.50	25

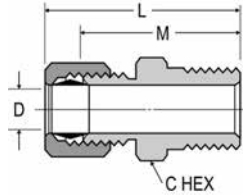

STRAIGHT THROUGH TANK FITTING 682C

Part Number	Tube Size	Pipe Thread	Straight Thread	Hex C	L	M	Flow Diameter D	Std. Pkg.
682C-0302	3/16	1/8	3/8-24	7/16	1.06	.84	.195	10
682C-0606	3/8	3/8	9/16-24	11/16	1.44	1.16	.387	10
682C-0808	1/2	1/2	11/16-20	7/8	1.90	1.31	.516	10

Specifications:

Listed with Underwriter's Laboratories for flammable liquid. Compression fittings meet functional requirements of SAE J-512, ASA and ASME.

Applications:

Use with copper, aluminum and thermoplastic tubing. Not recommended for steel tubing. Manufactured for low and medium pressure tubing connection work where excessive vibration or tube movement is not involved. Not recommended for applications using gaseous media.

Working Pressure Ranges:

Temperature and type of tubing used are important factors and the table to the right is a good guide for proper selection. Temperature 73°F. For thermoplastic tubing see manufacturers recommendation for pressure range.

Temperature Ranges:

From -65° to +250°F with soft metal tubing. For thermoplastic tubing see manufacturers recommendation for tubing temperature range.

Assembly Instructions:

1. Slide nut, then sleeve onto tubing. The thread end of the nut must face out.
2. Insert the tube into the fitting. Be sure the tube is bottomed on the fitting shoulder.
3. Assemble nut to body, and tighten 'hand tight'. Then follow the number of wrench turns as indicated in the table to the right.

PSI	Tube OD (inches)	Tube Wall (inches)
400	1/8	.030
400	3/16	.030
300	1/4	.030
300	5/16	.032
200	3/8	.032
200	1/2	.032
150	5/8	.035
100	3/4	.035
75	7/8	.035

Fitting Size	Tube Size	Turns required to seal from hand tight	
		60C with soft metal tubing	60C with thermoplastic tubing
2	1/8	1-1/4	--
3	3/16	1-1/4	--
4	1/4	1-1/4	2
5	5/16	1-1/4	2
6	3/8	2-1/4	2
8	1/2	2-1/4	2
10	5/8	2-1/4	2
12	3/4	2-1/4	2
14	7/8	2-1/4	--

D.O.T. Air Brake Fittings - Nylon Tubing

Features:

- maximum working pressure: 150 PSI
- temperature range: -40°F to + 200°F



TUBING NAB

Reference SAE J844, TYPE A and B, D.O.T. FMVSS 106

Part Number	Tube Size	Standard Color	Std. Pkg.
NAB3	3/16	black	100'
NAB4	1/4	black	100'
NAB4B	1/4	blue	100'
NAB4R	1/4	red	100'
NAB6	3/8	black	100'
NAB6B	3/8	blue	100'
NAB6R	3/8	red	100'
NAB8	1/2	black	100'
NAB10	5/8	black	100'
NAB12	3/4	black	100'

TUBING CUTTER

Part Number	Description
TC97	Maximum OD 9/16"
TC97RB	Replacement blade



Assembly Instructions:

1. Cut tubing squarely - maximum of 15° angle allowance.
2. Check that port or mating part is clean and free of debris.
3. Insert tubing into fitting until it bottoms on seat.
4. Tighten nut with wrench until one thread remains visible on the fitting body (this will allow for a number of remakes) or, the nut should be screwed down finger tight, then the wrench-tightened as indicated in the table to the right.

Tube Size	Additional number of turns from hand tight
1/4	3
3/8 and 1/2	4
5/8 and 3/4	3-1/2

SLEEVE 60NAB

Reference SAE 100115

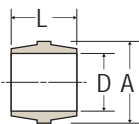

Part Number	Tube Size	A	D	L	Std. Pkg.
60NAB3	3/16	.255	.194	.23	100
60NAB4	1/4	.356	.256	.30	100
60NAB6	3/8	.479	.384	.39	100
60NAB8	1/2	.624	.509	.43	100
60NAB10	5/8	.746	.634	.49	100
60NAB12	3/4	.922	.760	.54	50

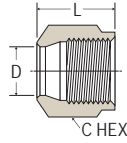

NUT 61NAB

Reference SAE 100110

Part Number	Tube Size	Straight Thread	Hex C	D	L	Std. Pkg.
61NAB3	3/16	5/16-24	7/16	.194	.40	100
61NAB4	1/4	7/16-24	9/16	.256	.45	100
61NAB6	3/8	17/32-24	5/8	.384	.63	100
61NAB8	1/2	11/16-20	13/16	.509	.72	50
61NAB10	5/8	13/16-18	15/16	.634	.77	25
61NAB12	3/4	1-18	1-1/8	.762	.81	25

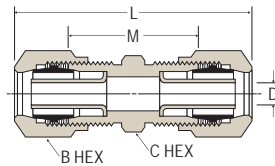

UNION 62NAB

Reference SAE 100101 BA

Part Number	Tube Size	Straight Thread	Hex B	Hex C	L	M	Flow D	Std. Pkg.
62NAB4	1/4	7/16-24	9/16	7/16	1.49	.83	.137	10
62NAB6	3/8	17/32-24	5/8	9/16	2.00	1.08	.217	10
62NAB8	1/2	11/16-20	13/16	11/16	2.33	1.29	.338	10
62NAB10	5/8	13/16-18	15/16	13/16	2.39	1.41	.398	10
62NAB12	3/4	1-18	1-1/8	1	2.60	1.58	.523	10

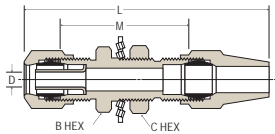

BULKHEAD UNION 62NABH
(NAB and air brake)

Part Number	Tube Size	Straight Thread	Hex B	Hex C	L	M	Flow D	Std. Pkg.
62NABH4	1/4	7/16-24	9/16	9/16	2.28	1.38	.137	10
62NABH6	3/8	17/32-24	11/16	3/4	2.97	1.62	.217	10
62NABH8	1/2	11/16-20	13/16	1	3.36	1.88	.338	10

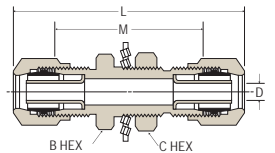

BULKHEAD UNION 62NBH

Part Number	Tube Size	Straight Thread	Hex B	Hex C	L	M	Flow D	Std. Pkg.
62NBH3	3/16	5/16-24	7/16	7/16	1.80	1.21	.087	10
62NBH4	1/4	7/16-24	9/16	9/16	2.04	1.38	.137	10
62NBH6	3/8	17/32-24	11/16	3/4	2.54	1.62	.21	10
62NBH8	1/2	11/16-20	13/16	1	2.92	1.88	.33	10
62NBH10	5/8	13/16-18	15/16	1	3.04	2.02	.398	10

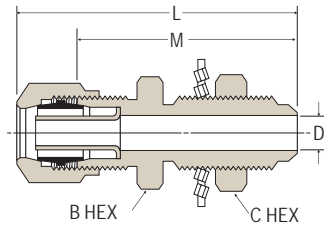

BULKHEAD UNION 62NFBH

Part Number	Tube Size	Straight Thread	Hex B	Hex C	L	M	D	Std. Pkg.
62NFBH4	1/4	7/16-24	9/16	9/16	2.04	1.38	.137	10
62NFBH6	3/8	17/32-24	11/16	3/4	2.54	1.62	.217	10
62NFBH8	1/2	11/16-20	13/16	1	2.92	1.88	.338	10
62NFBH10	5/8	13/16-18	15/16	1	3.04	2.02	.398	10

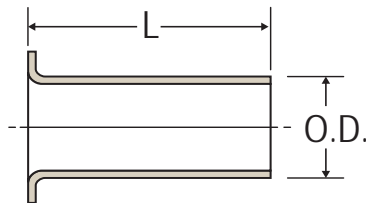

STAINLESS INSERT 63NAB
(for SAE J844 tubing)

Part Number	Tube Size	L	OD	Std. Pkg.
63NAB4	1/4	.53	.163	200
63NAB6	3/8	.64	.245	200
63NAB8	1/2	.81	.370	100
63NAB10	5/8	.86	.434	100
63NAB12	3/4	1.04	.559	100

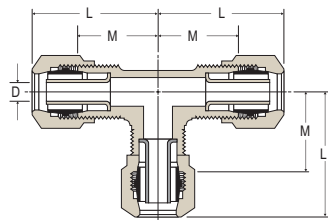

UNION TEE 64NAB
Reference SAE 100401 BA

Part Number	Tube Size	Straight Thread	L	M	Flow D	Std. Pkg.
64NAB4	1/4	7/16-24	.95	.62	.13	25
64NAB6	3/8	17/32-24	1.24	.78	.21	25
64NAB8	1/2	11/16-20	1.45	.93	.33	10
64NAB10	5/8	13/16-18	1.58	1.09	.39	10

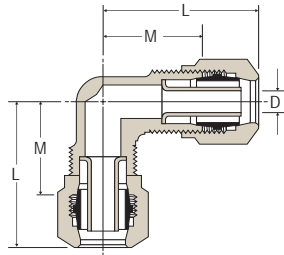

UNION ELBOW 65NAB
Reference SAE 100201 BA

Part Number	Tube Size	Straight Thread	L	M	Flow D	Std. Pkg.
65NAB4	1/4	7/16-24	.95	.62	.13	10
65NAB6	3/8	17/32-24	1.25	.79	.21	10
65NAB8	1/2	11/16-20	1.45	.93	.33	10
65NAB10	5/8	13/16-18	1.58	1.09	.39	10

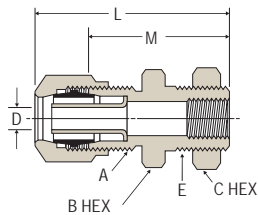

BULKHEAD UNION 66NBH

Part Number	Tube Size	Pipe Size	Straight Thread A	Straight Thread E	Hex B	Hex C	L	M	Flow D	Std. Pkg.
66NBH86	1/2	3/8	11/16-20	7/8-14	1-1/16	1-1/16	1.94	1.42	.338	10

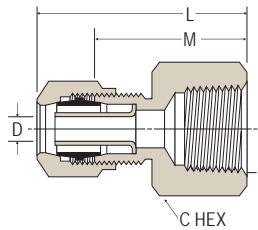

FEMALE CONNECTOR 66NAB
Reference SAE 100103 BA

Part Number	Tube Size	Pipe Thread	Straight Thread	Hex C	L	M	Flow D	Std. Pkg.
66NAB42	1/4	1/8	7/16-24	9/16	1.17	.84	.13	25
66NAB44		1/4	7/16-24	11/16	1.40	1.07	.13	10
66NAB62	3/8	1/8	17/32-24	9/16	1.46	1.00	.21	10
66NAB64		1/4	17/32-24	11/16	1.64	1.18	.21	10
66NAB86 *	1/2	3/8	11/16-20	7/8	1.79	1.27	.33	10
66NAB88		1/2	11/16-20	1-1/16	1.91	1.38	.33	10
66NAB106	5/8	3/8	13/16-18	7/8	1.87	1.38	.39	10
66NAB108		1/2	13/16-18	1-1/16	1.99	1.60	.39	10

* Not full hex as shown

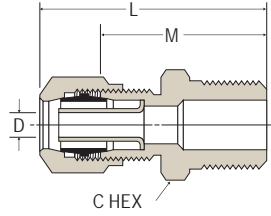

MALE CONNECTOR 68NAB

Reference SAE 100102 BA

Thread sealant may be white or burnt orange

Part Number	Tube Size	Pipe Thread	Straight Thread	Hex C	L	M	Flow D	Std. Pkg.
68NAB31VS	3/16	1/16	5/16-24	3/8	1.16	.87	.087	25
68NAB32VS		1/8	5/16-24	7/16	1.15	.86	.087	50
68NAB34VS		1/4	5/16-24	9/16	1.35	1.05	.087	25
68NAB42VS	1/4	1/8	7/16-24	7/16	1.22	.89	.13	50
68NAB44VS		1/4	7/16-24	9/16	1.43	1.09	.13	50
68NAB46VS		3/8	7/16-24	11/16	1.47	1.14	.13	10
68NAB62VS	3/8	1/8	17/32-24	9/16	1.49	1.03	.21	25
68NAB64VS		1/4	17/32-24	9/16	1.67	1.21	.21	25
68NAB66VS		3/8	17/32-24	11/16	1.70	1.21	.21	25
68NAB68VS		1/2	17/32-24	7/8	1.89	1.43	.21	25
68NAB84VS	1/2	1/4	11/16-20	11/16	1.85	1.32	.33	10
68NAB86VS		3/8	11/16-20	11/16	1.85	1.32	.33	25
68NAB88VS		1/2	11/16-20	7/8	2.04	1.52	.33	25
68NAB106VS	5/8	3/8	13/16-18	13/16	1.86	1.37	.398	10
68NAB108VS		1/2	13/16-18	7/8	2.07	1.56	.398	10
68NAB126VS	3/4	3/8	1-18	1	2.00	1.49	.440	10
68NAB128VS		1/2	1-18	1	2.19	1.68	.523	10
68NAB1212VS		3/4	1-18	1-1/16	2.22	1.71	.523	10

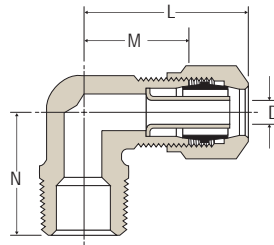

MALE ELBOW 69NAB

Reference SAE 100202 BA

Thread sealant may be white or burnt orange

Part Number	Tube Size	Pipe Thread	Straight Thread	L	M	N	Flow D	Std. Pkg.
69NAB32VS	3/16	1/8	5/16-24	.90	.60	.67	.087	10
69NAB34VS		1/4	5/16-24	.91	.62	.87	.087	10
69NAB42VS	1/4	1/8	7/16-24	.95	.62	.66	.13	50
69NAB44VS		1/4	7/16-24	1.00	.68	.87	.13	50
69NAB46VS		3/8	7/16-24	1.16	.73	.86	.13	10
69NAB62VS	3/8	1/8	17/32-24	1.19	.73	.75	.21	10
69NAB64VS		1/4	17/32-24	1.25	.79	.92	.21	25
69NAB66VS		3/8	17/32-24	1.30	.84	.91	.21	25
69NAB68VS		1/2	17/32-24	1.40	.94	1.10	.21	10
69NAB84VS	1/2	1/4	11/16-20	1.38	.86	.99	.33	10
69NAB86VS		3/8	11/16-20	1.44	.92	.99	.33	10
69NAB88VS		1/2	11/16-20	1.55	1.03	1.18	.33	10
69NAB106VS	5/8	3/8	13/16-18	1.49	1.00	1.05	.39	10
69NAB108VS		1/2	13/16-18	1.58	1.09	1.24	.39	5
69NAB128VS	3/4	1/2	1-18	1.70	1.19	1.33	.52	5
69NAB1212VS		3/4	1-18	1.77	1.26	1.32	.52	5

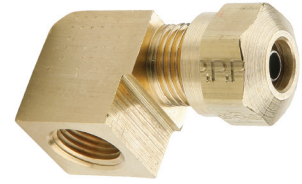
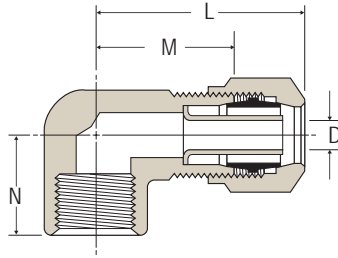

FEMALE ELBOW 70NAB
Reference SAE 100203 BA

Part Number	Tube Size	Pipe Thread	Straight Thread	L	M	N	Flow D	Std. Pkg.
70NAB32	3/16	1/8	5/16-24	.96	.67	.52	.087	10
70NAB42	1/4	1/8	7/16-24	1.02	.69	.52	.13	10
70NAB44		1/4	7/16-24	1.11	.78	.71	.13	50
70NAB62	3/8	1/8	17/32-24	1.29	.83	.59	.21	50
70NAB64 *		1/4	17/32-24	1.25	.80	.58	.21	10
70NAB66		3/8	17/32-24	1.39	.93	.77	.21	10
70NAB86	1/2	3/8	11/16-20	1.55	1.03	.82	.33	25
70NAB88		1/2	11/16-20	1.65	1.13	1.01	.33	25
70NAB108	5/8	1/2	13/16-18	1.70	1.19	1.07	.39	10

* Rounded elbow - part not as pictured

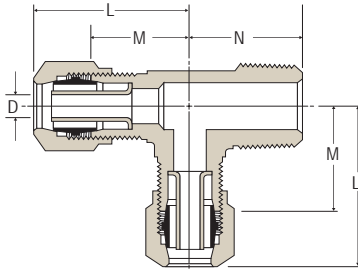

MALE RUN TEE 71NAB
Reference SAE 100424 BA

Thread sealant may be white or burnt orange

Part Number	Tube Size	Pipe Thread	Straight Thread	L	M	N	Flow D	Std. Pkg.
71NAB42VS	1/4	1/8	7/16-24	.95	.62	.66	.13	10
71NAB44VS		1/4	7/16-24	1.00	.68	.87	.13	10
71NAB64VS	3/8	1/4	17/32-24	1.25	.79	.92	.21	10
71NAB66VS		3/8	17/32-24	1.30	.84	.91	.21	10
71NAB86VS	1/2	3/8	11/16-20	1.45	.93	.99	.33	10
71NAB88VS		1/2	11/16-20	1.55	1.03	1.18	.33	10
71NAB108VS	5/8	1/2	13/16-18	1.60	1.09	1.24	.39	10

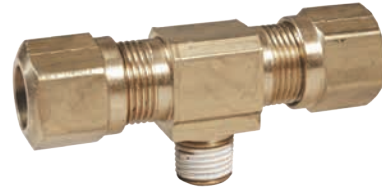
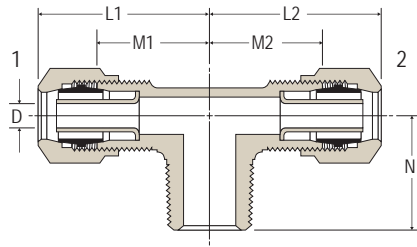

MALE BRANCH TEE 72NAB

Reference SAE 100425 BA

Thread sealant may be white or burnt orange

Part Number	Tube 1	Tube 2	Pipe Thread	Straight Thread	L ¹	L ²	M ¹	M ²	N	Flow D	Std. Pkg.
72NAB32VS	3/16	3/16	1/8	7/16-24	.90	.90	.61	.61	.66	.087	10
72NAB42VS	1/4	1/4	1/8	7/16-24	.95	.95	.62	.62	.66	.13	10
72NAB44VS		1/4	1/4	7/16-24	1.00	1.00	.68	.68	.87	.13	10
72NAB62VS	3/8	3/8	1/8	17/32-24	1.18	1.18	.72	.72	.75	.217	10
72NAB64VS		3/8	1/4	17/32-24	1.25	1.25	.81	.81	.92	.21	10
72NAB66VS		3/8	3/8	17/32-24	1.30	1.30	.84	.84	.91	.21	10
72NAB84VS	1/2	1/2	1/4	11/16-20	1.41	1.41	.89	.89	.99	.33	10
72NAB86VS		1/2	3/8	11/16-20	1.45	1.45	.93	.93	.99	.33	10
72NAB88VS		1/2	1/2	11/16-20	1.55	1.55	1.03	1.03	1.17	.33	10
72NAB108VS	5/8	5/8	1/2	13/16-18	1.60	1.60	1.09	1.09	1.24	.39	10

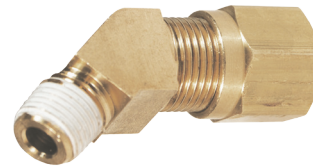
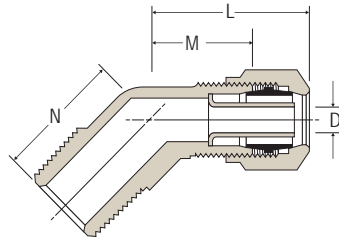

45° ELBOW 79NAB

Reference SAE 100302 BA

Thread sealant may be white or burnt orange

Part Number	Tube Size	Pipe Thread	Straight Thread	L	M	N	Flow D	Std. Pkg.
79NAB42VS	1/4	1/8	7/16-24	.81	.49	.63	.13	10
79NAB44VS		1/4	7/16-24	.93	.60	.85	.13	10
79NAB62VS	3/8	1/8	17/32-24	1.17	.71	.68	.21	10
79NAB64VS		1/4	17/32-24	1.17	.71	.85	.21	10
79NAB66VS		3/8	17/32-24	1.21	.75	.94	.21	10
79NAB68VS	1/2	1/2	17/32-24	1.24	.78	1.16	.21	10
79NAB84VS		1/4	11/16-20	1.36	.84	.94	.33	10
79NAB86VS		1/2	3/8	11/16-20	1.36	.84	.94	.33
79NAB88VS	5/8	1/2	11/16-20	1.39	.87	1.16	.33	10
79NAB106VS		3/8	13/16-18	1.43	.94	.98	.39	10
79NAB108VS		1/2	13/16-18	1.42	.93	1.16	.39	10
79NAB128VS	3/4	1/2	1-18	1.61	1.10	1.18	.51	10

56RBSG
Spring

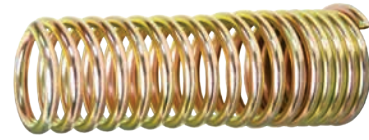
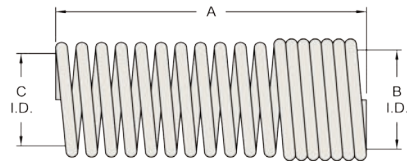

Part Number	Hose Size	A	B	C	Std. Pkg.
56RBSG-06	3/8	2.70	.87	.87	10
56RBSG-08	1/2	2.70	.96	.96	10

60RB
Sleeve

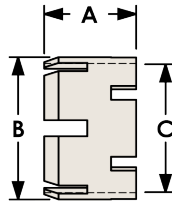

Part Number	Hose Size	A Length	B O.D.	C I.D.	Std. Pkg.
60RB-06	3/8	.64	.91	.80	10
60RB-08	1/2	.64	1.02	.92	5

61RB
Nut

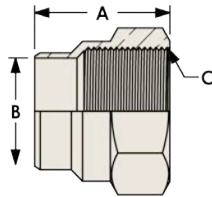

Part Number	Hose Size	C Thread	Hex	A Length	B I.D.	Std. Pkg.
61RB-06	3/8	31/32-20	1-1/32	1.19	.78	10
61RB-08	1/2	1-3/32-20	1-1/4	1.20	.92	10

61RBSG
Spring Guard Nut

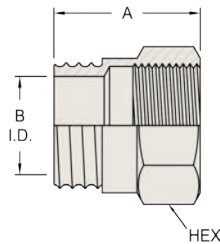

Part Number	Hose Size	Straight Thread	Hex	A	B	Std. Pkg.
61RBSG-06	3/8	31/32-20	1-1/32	1.20	.78	10
61RBSG-08	1/2	1-3/32-20	1-1/4	1.20	.92	10

67RBSG
Air Brake Hose Nut & Attached Spring

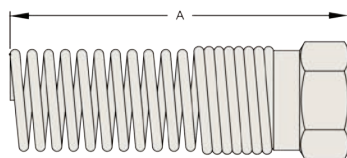

Part Number	Length	Std. Pkg.
67RBSG-06	3.55	10
67RBSG-08	3.50	10

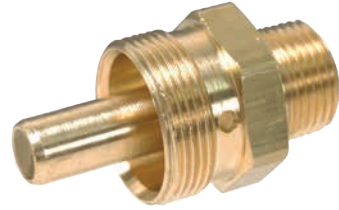
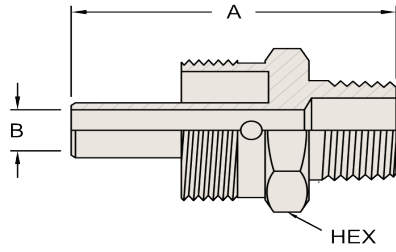

68RB
Male Connector Body Only

Part Number	Hose Size	Straight Thread	Pipe Thread	Hex	A	B	Std. Pkg.
68RB-0604B	3/8	31/32-20	1/4	31/32	1.93	.299	10
68RB-0606B		31/32-20	3/8	31/32	1.93	.299	10
68RB-0608B		31/32-20	1/2	31/32	2.12	.299	10
68RB-0806B	1/2	1-3/32-20	3/8	1-1/8	1.96	.397	5
68RB-0808B		1-3/32-20	1/2	1-1/8	2.15	.397	5

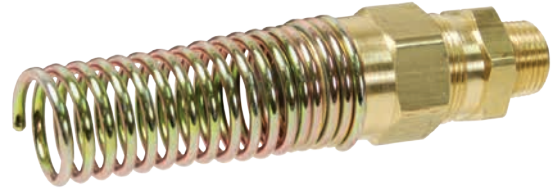
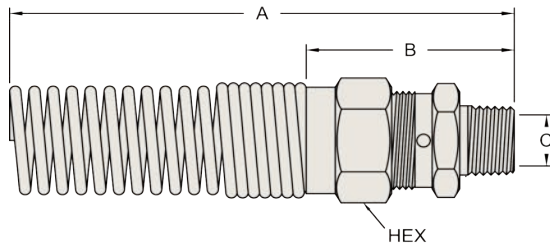

68RBSG
Male Connector With Spring Guard

Part Number	Hose Size	Pipe Thread	Hex	A	B	C	Std. Pkg.
68RBSG-0604	3/8	1/4	1-1/16	4.69	1.96	.299	2
68RBSG-0606		3/8	1-1/16	4.8	2.05	.299	2
68RBSG-0608		1/2	1-1/16	4.9	2.15	.299	2
68RBSG-0806	1/2	3/8	1-1/4	5.0	2.00	.397	2
68RBSG-0808		1/2	1-1/4	5.25	2.25	.397	2

Warranty

Dixon Brass (the 'Company') guarantees the products shown in this publication against defects in material and workmanship for one year from the date of shipment, provided the products are used under normal operating conditions. All claims for product defects are waived unless reported to the Company in writing within thirty days after a buyer has knowledge of such a defect. THE ABOVE GUARANTEE IS THE SOLE WARRANTY GIVEN BY THE COMPANY, AND ALL OTHER WARRANTIES, INCLUDING THE IMPLIED WARRANTIES OF MERCHANTABILITY AND FITNESS FOR A PARTICULAR PURPOSE, ARE HEREBY EXPRESSLY DISCLAIMED AND EXCLUDED.

A buyer's sole and exclusive remedy for the breach of any warranty of the Company shall be the replacement of the products determined by the Company to be defective or, at the Company's option the refund of the invoiced price of such products. A buyer shall not recover special, indirect, or consequential damages for the breach of any warranty made by the Company to the buyer.

All brass fittings shown in this publication are manufactured from Alloy CDA 353, 360 or 377. The fittings should not be exposed to aggressive or destructive atmospheres which may corrode the fittings, including but not limited to ammonia, nitrogen, hydrocarbons or mercury atmospheres.

Additional application data and assistance can be obtained by writing the Company's Sales Department.

Because of the health hazards associated with contamination and lead content in drinking water systems, Dixon couplings, unless otherwise specifically approved, are not recommended for potable water service and should not be used in applications where drinking water will contact the wetted surfaces of the couplings.

Size Comparisons

Actual Outside Diameters of Pipe Threads

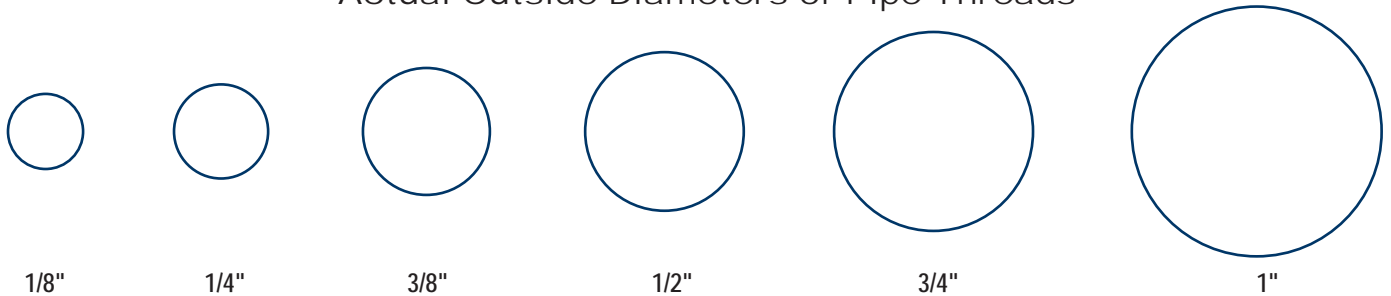

Actual Outside Diameters of Tubing

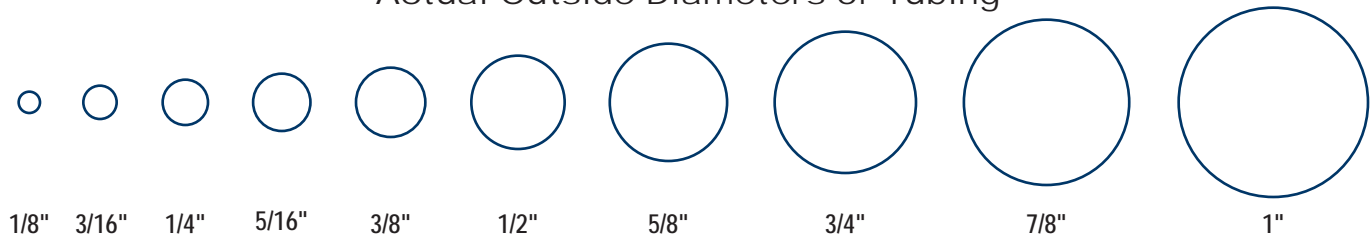

Male Thread Profiles



Customer Service:

800.323.4440

Fax:

800.628.7259

Customer Service Email

customer.service@dixonbrass.com



The Right Connection™

Dixon Brass

40 Chestnut Avenue
Westmont, IL 60559-1128
800-323-4440
Fax: 800-628-7259
dixonbrass.com

Stay connected with Dixon on:



dixonvalve.com



customer service

