

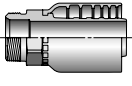





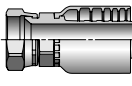

 <p>NPTF Pipe</p>	<p>101S6 B-118</p>  <p><i>Male - Rigid</i></p>	 <p>JIC 37°</p>	<p>106S6 B-118</p>  <p><i>Female - Swivel</i></p>	 <p>Code 61 Flange</p>	<p>14AS6 B-118</p>  <p><i>Flange (5000 psi)</i></p>
<p>14FS6 B-118</p>  <p><i>45° Elbow (5000 psi)</i></p>	<p>14NS6 B-118</p>  <p><i>90° Elbow (5000 psi)</i></p>	 <p>Code 62 Flange</p>	<p>16AS6 B-119</p>  <p><i>Flange Head - Straight</i></p>	<p>16FS6 B-119</p>  <p><i>45° Elbow</i></p>	<p>16NS6 B-119</p>  <p><i>90° Elbow</i></p>
 <p>Caterpillar® Flange</p>	<p>1XAS6 B-119</p>  <p><i>Flange</i></p>	 <p>Seal-Lok® (O-Ring Face Seal)</p>	<p>1JSS6 B-119</p>  <p><i>Female - Swivel</i></p>		

A

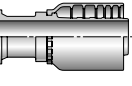
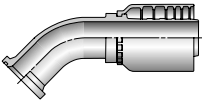
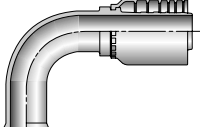
B

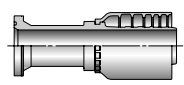
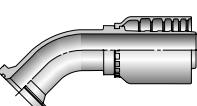
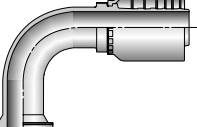

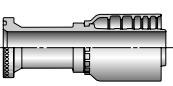
C

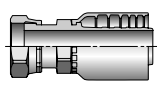
D

E

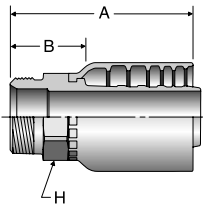
101S6 Male NPTF Pipe - Rigid





#			A		H	B	
Part Number	Thread inch	Hose I.D. inch	inch	mm	inch	inch	mm
101S6-32-32	2 x 11 1/2	2	5.88	149,5	2-1/2	2.44	61,9

101S6 is rated at 5,000 psi working pressure.

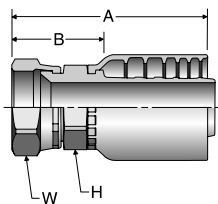
106S6 Female JIC 37° - Swivel





#			A		H	B	
Part Number	Thread inch	Hose I.D. inch	inch	mm	inch	inch	mm
106S6-32-32	2 1/2 x 12	2	6.52	165,7	2.5	3.08	78,2

106S6 is rated at 5,000 psi working pressure.

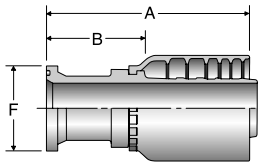

14AS6 SAE Code 61 Flange Head - 5,000 psi ISO 12151-3-S-L (5,000 psi)



#			A		F	B		E	
Part Number	Flange inch	Hose I.D. inch	inch	mm	inch	inch	mm	inch	mm
14AS6-32-32	2	2	6.72	170,8	2-13/16	3.28	83,3	-	-

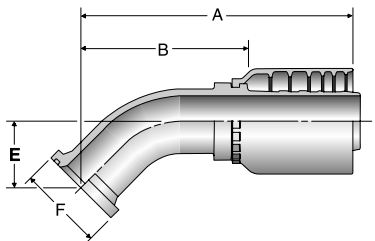

14FS6 SAE Code 61 Flange Head - 45° Elbow - 5,000 psi ISO 12151-3-E-45S-L (1 Piece: ISO 12151-3-E45M-L) (5,000 psi)

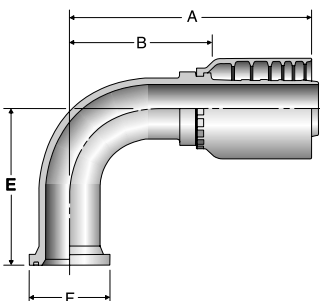

#			A		F	B		E	
Part Number	Flange inch	Hose I.D. inch	inch	mm	inch	inch	mm	inch	mm
14FS6-32-32	2	2	8.70	221,1	2-13/16	5.26	133,6	2.205	56,0

14NS6 SAE Code 61 Flange Head - 90° Elbow - 5,000 psi ISO 12151-3-E-90S-L (1 Piece: ISO 12151-3-E90M-L) (5,000 psi)



#			A		F	B		E	
Part Number	Flange inch	Hose I.D. inch	inch	mm	inch	inch	mm	inch	mm
14NS6-32-32	2	2	8.41	213,7	2-13/16	4.97	126,2	5.433	138,0

16AS6

SAE Code 62 Flange Head

ISO 12151-3-S-S

# Part Number	Flange inch	Hose I.D. inch	A		F		B		E	
			inch	mm	inch	inch	mm	inch	mm	
16AS6-32-32	2	2	8.21	208,6	3-1/8	4.77	121,1	-	-	

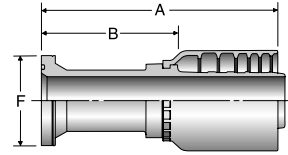

16FS6

SAE Code 62 Flange Head - 45° Elbow

ISO 12151-3-E45S-S (1 Piece: ISO 1251-3-E45-M-S)

# Part Number	Flange inch	Hose I.D. inch	A		F		B		E	
			inch	mm	inch	inch	mm	inch	mm	
16FS6-32-32	2	2	8.70	221,1	3-1/8	5.26	133,6	2.205	56,0	

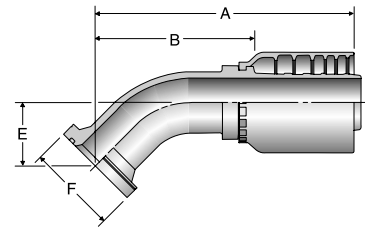

16NS6

SAE Code 62 Flange Head - 90° Elbow

ISO 12151-3-E90S-S (1 Piece: ISO 1251-3-E90M-S)

# Part Number	Flange inch	Hose I.D. inch	A		F		B		E	
			inch	mm	inch	inch	mm	inch	mm	
16NS6-32-32	2	2	8.41	213,7	3-1/8	4.97	126,2	5.43	138,0	

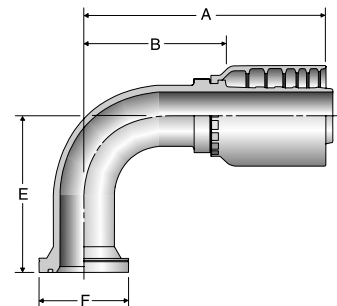

1XAS6

Caterpillar® Flange Head

# Part Number	Flange inch	Hose I.D. inch	A		F		B	
			inch	mm	inch	inch	mm	
1XAS6-32-32	2	2	8.21	208,6	3-1/8	4.77	121	

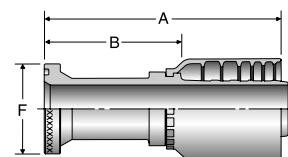

1JSS6

Female Seal-Lok - Swivel - Long

ISO 12151-1-SWSB

# Part Number	Thread inch	Hose I.D. inch	A		H		W		B	
			inch	mm	inch	inch	inch	mm		
1JSS6-32-32	2-1/2X12	2	6.46	164,2	2.5	2-7/8	3.02	76,7		

